

G900-011

NON-VENTILATION UNIT SHOWN

1 7/8" (HORIZONTAL OPTION) (FLANGE WIDTH)

81" (HORIZONTAL OPTION) (RETURN WIDTH)

3 1/8"

SEE ENERGY RECOVERY OPTIONS PAGE(S) FOR DETAILS

UH (UNIT HEIGHT)

H2 (HORIZONTAL OPTION) (RETURN HEIGHT)

H3 (HORIZONTAL OPTION)

OPTIONAL OUTDOOR HOODS OMITTED FOR CLARITY SEE OA BOX OPTION PAGES FOR DETAILED INFORMATION

BOTTOM RETURN OPTION LOCATION

BOTTOM RETURN OPTION DETAIL

51 3/8" 4 1/8"

79"

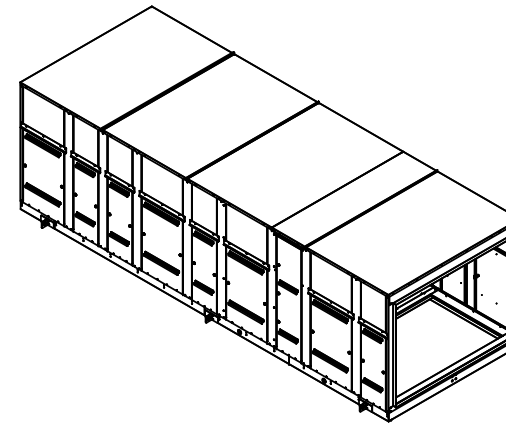

UNIT TYPE	MODEL SIZE	RL	L1	UH	H2	H3
WITHOUT ENERGY RECOVERY	35	243 7/8	244	73 7/8	59	7 5/8
	40	243 7/8	244	73 7/8	59	7 5/8
	45	243 7/8	244	88 7/8	74	7 5/8
	50	243 7/8	244	88 7/8	74	7 5/8
WITH ENERGY RECOVERY	35	243 7/8	244	73 7/8	59	7 5/8
	40	243 7/8	244	73 7/8	59	7 5/8
	45	243 7/8	244	88 7/8	74	7 5/8
	50	243 7/8	244	88 7/8	74	7 5/8

FILTER OPTION	MODEL SIZE	PART NUMBER	QTY	NOM WIDTH	NOM HEIGHT	NOM DEPTH			
DISPOSABLE	35	870-028	12	16	20	4			
		870-041	3	24					
	40	870-028	12	16	20	4			
		870-041	3	24					
45	870-035	9	25	29	4				
	870-035	9	25	29					
DEACTIVATOR	35	872-006	3	16	20	2			
		870-043	3						
		872-009	3	24					
		870-057	3						
	40	872-006	3	16	20	2			
		870-043	3						
		872-009	3	24					
		870-057	3						
	45	872-010	6	25	29	2			
		870-009	6						
		50	872-006	6			25	29	2
			870-043	6					
872-009	3								
870-057	3								

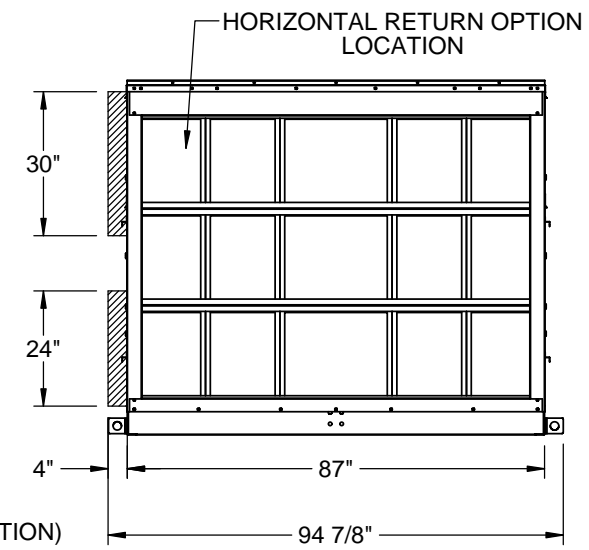

GENERAL NOTES FOR APPLICABLE SHEETS:
 VIEWS ARE FOR PICTORAL PURPOSES.
 REFER TO SUBMITTAL FOR CUSTOMER CONNECTION LOCATIONS.
 DIMENSIONS ARE TO ACCESS SIDE OF UNIT.
 LH ACCESS SHOWN FOR DISPLAY PURPOSES. ACCESS DOOR CONFIGURATION MAY CHANGE DEPENDING ON UNIT SIZE OR TYPE
 REFER TO SHEET 4,5,6 FOR INTAKE AND DISCHARGE CONNECTION DIMENSIONS.

Desert Aire has a policy of continuous product and quality improvement. Specifications and dimensions are subject to change without notice. This drawing and information contained herein are the exclusive property of the Desert Aire Corporation. Any use detrimental to the interests of Desert Aire is prohibited.

All Dimensions in Inches
 All Angles 90°
 All outside corners 0.125" fillet
 Unless Otherwise Specified

Tolerance Unless Otherwise Specified
 X.X ±.125
 X.XX ±.060
 X.XXX ±.030
 Angles ±1°

DESERT AIRE
 N120 W18485 FREISTADT RD
 GERMANTOWN, WI 53022
 Tel: (262) 946-7400
 Fax: (262) 946-7401

Drawn: ASV Date Released: 12/5/2014 Description: SA35-50 EXT RETURN w/AUX HEAT
 Sheet: 1/8 Page Title: GENERAL INFORMATION
 Scale: NTS Rev: 0 Drawing Number: G900-011

Third Angle Projection

ALL DIMENSIONS ARE IN INCHES FRACTIONAL TOLERANCE ± 1/8"

G900-011

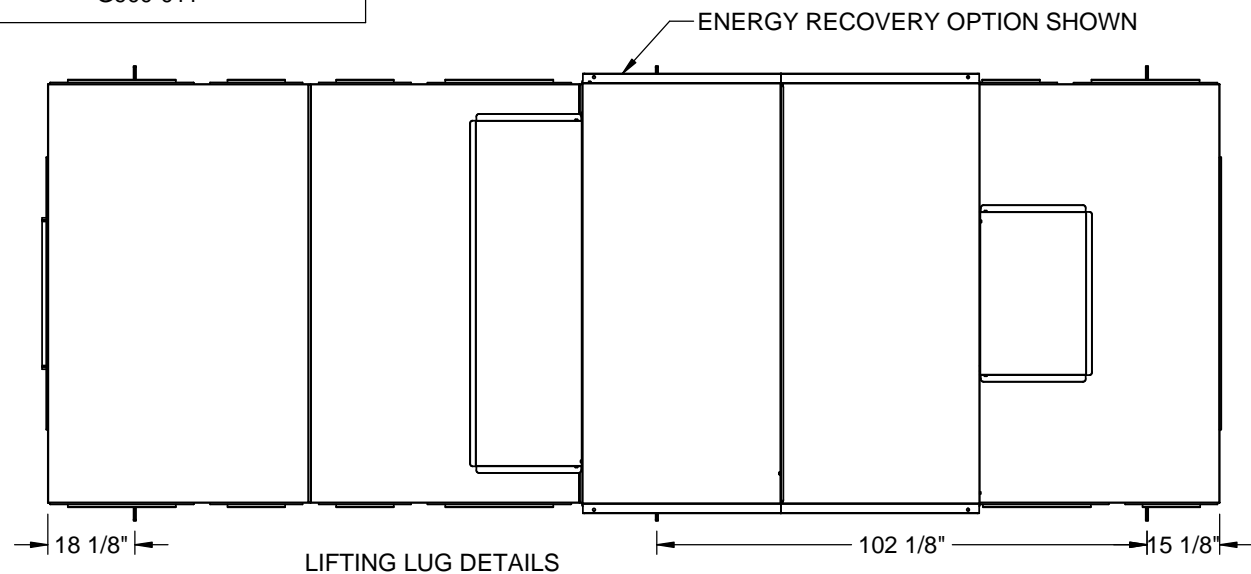

UNIT TYPE	MODEL SIZE	POOL WATER		CIRCUIT A		CIRCUIT B	
		CIRCUIT A	CIRCUIT B	DISCH DIA	LIQUID DIA	DISCH DIA	LIQUID DIA
WITHOUT ENERGY RECOVERY	35	1 1/2	2	1 1/8	3/4	1 3/8	3/4
	40	1 1/2	2	1 1/8	3/4	1 3/8	1 1/8
	45	2	2	1 3/8	7/8	1 3/8	7/8
	50	2	2	1 3/8	7/8	1 5/8	1 1/8
WITH ENERGY RECOVERY	35	1 1/2	2	1 1/8	3/4	1 3/8	3/4
	40	1 1/2	2	1 1/8	3/4	1 3/8	1 1/8
	45	2	2	1 3/8	7/8	1 3/8	7/8
	50	2	2	1 3/8	7/8	1 5/8	1 1/8

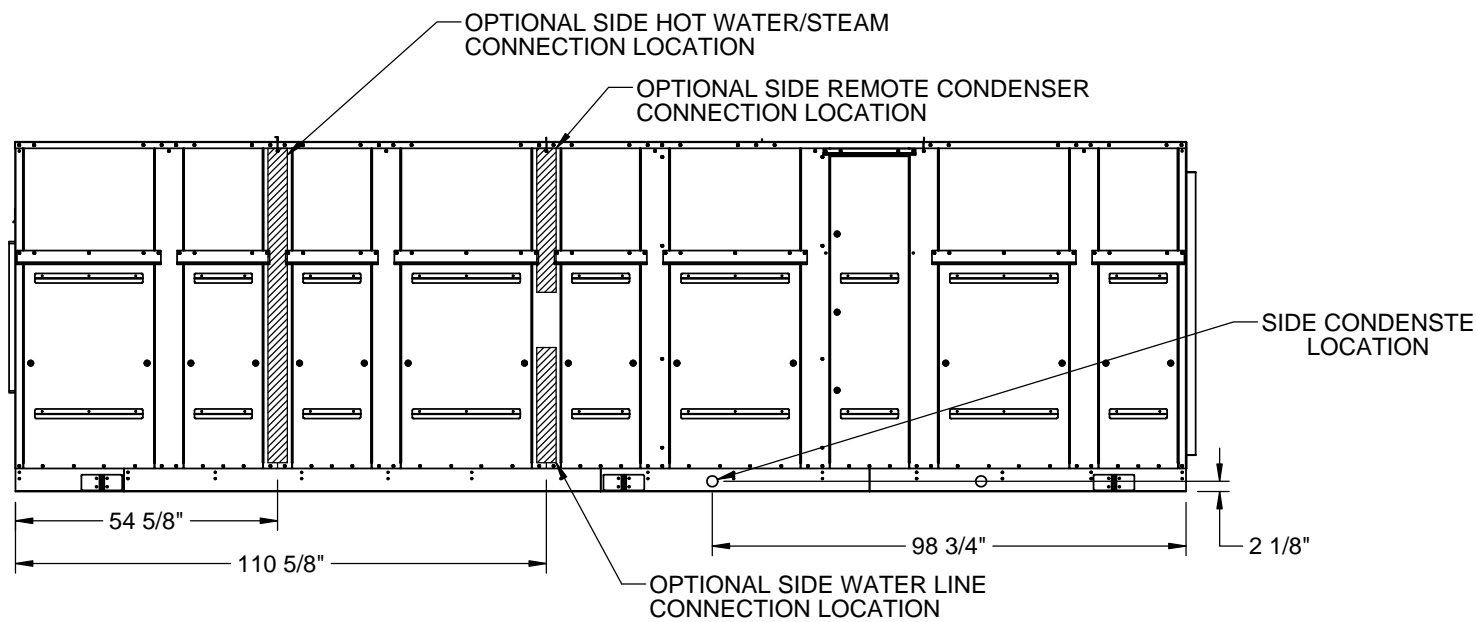

DUCT CONNECTION w/DAMPER OPTION SHOWN

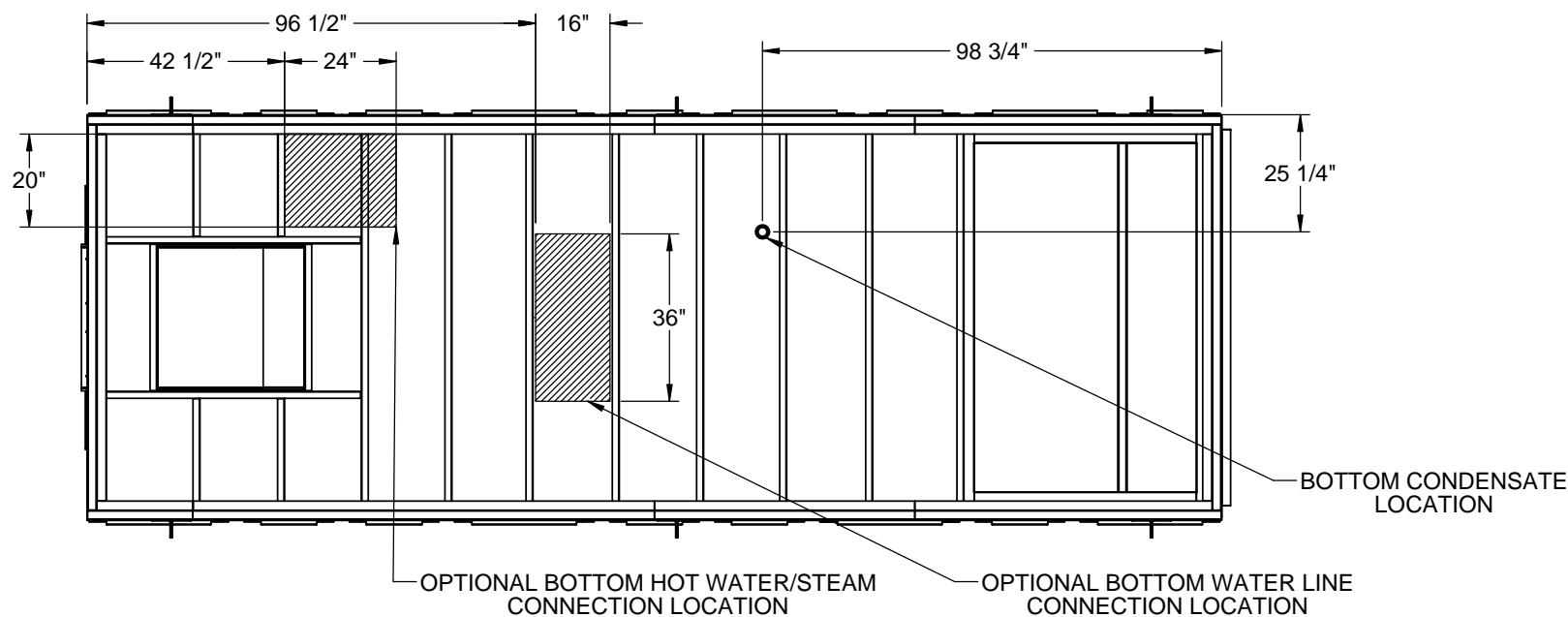
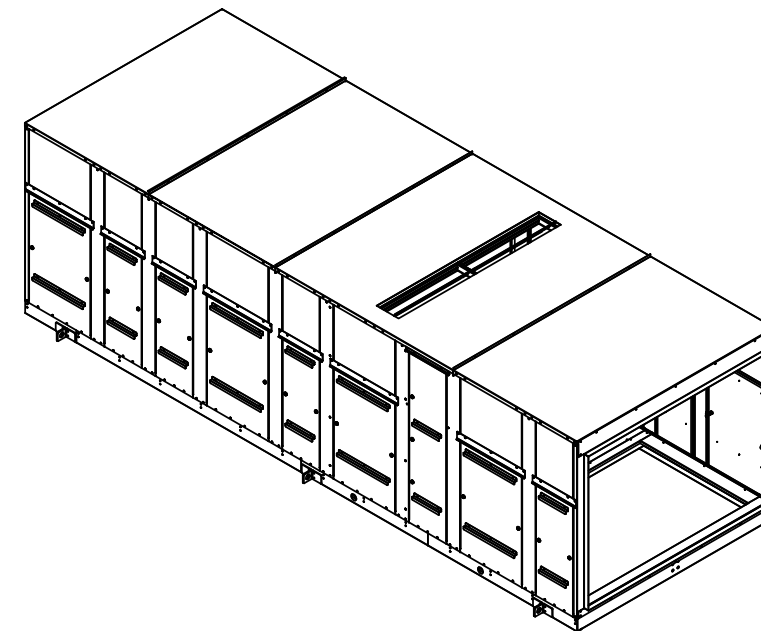
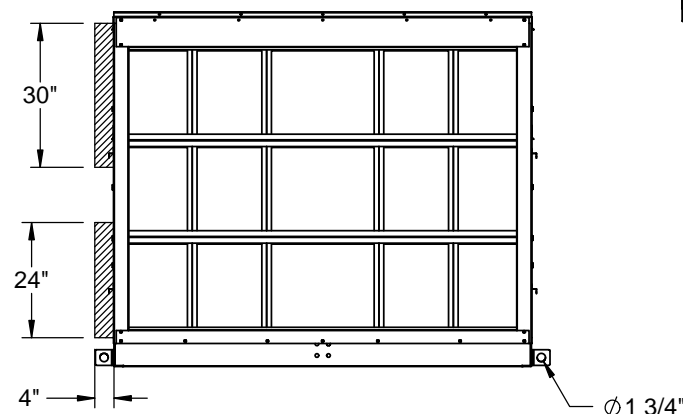

LEFT HAND CONNECTION OPTIONS SHOWN
RIGHT HAND CONNECTION OPTIONS LOCATED WITH SAME DIMENSIONS OPPOSITE SIDE WHEN SPECIFIED

Desert Aire has a policy of continuous product and quality improvement. Specifications and dimensions are subject to change without notice. This drawing and information contained herein are the exclusive property of the Desert Aire Corporation. Any use detrimental to the interests of Desert Aire is prohibited.	All Dimensions in Inches All Angles 90° All outside corners 0.125" fillet Unless Otherwise Specified	Tolerance Unless Otherwise Specified X.X ±.125 X.XX ±.060 X.XXX ±.030 Angles ±1°	<p>N120 W18485 FREISTADT RD GERMANTOWN, WI 53022 Tel: (262) 946-7400 Fax: (262) 946-7401</p>
ALL DIMENSIONS ARE IN INCHES FRACTIONAL TOLERANCE ± 1/8"	Third Angle Projection	Sheet 2/8	Page Title CUSTOMER CONNECTIONS
Part weight	Scale NTS	Rev. 0	Drawing Number G900-011

G900-011

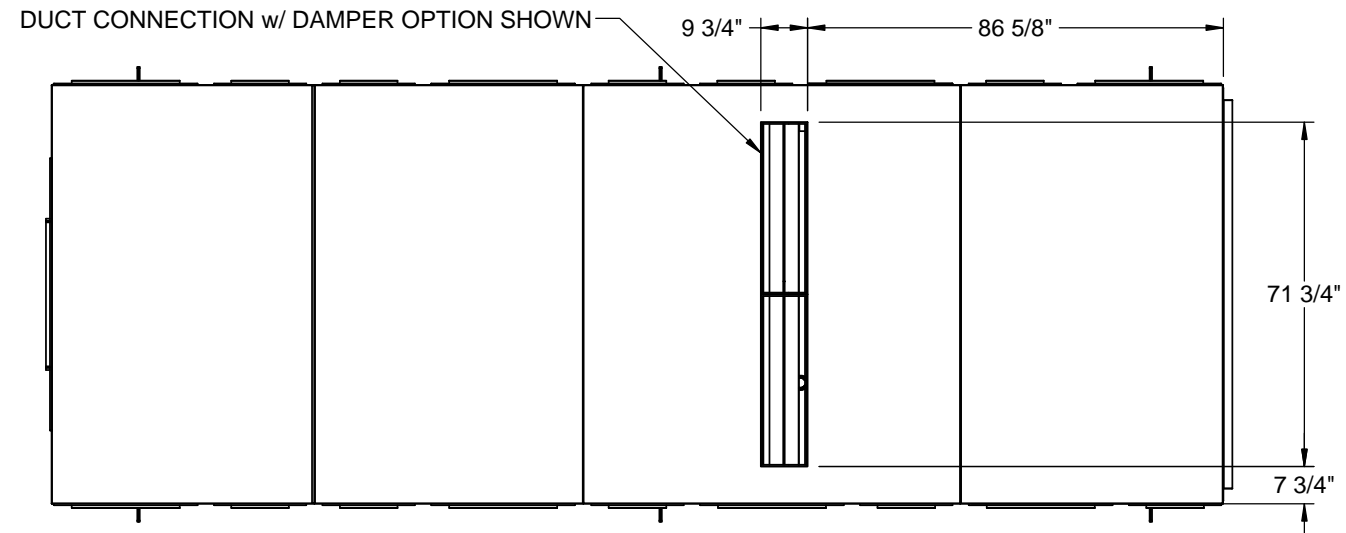

UNIT TYPE	MODEL SIZE	H1		
		NO VENTILATION	DUCT CONNECTION	OA BOX
WITHOUT ENERGY RECOVERY	35	73 7/8	73 7/8	102 1/4
	40	73 7/8	73 7/8	102 1/4
	45	88 7/8	88 7/8	117 1/4
	50	88 7/8	88 7/8	117 1/4

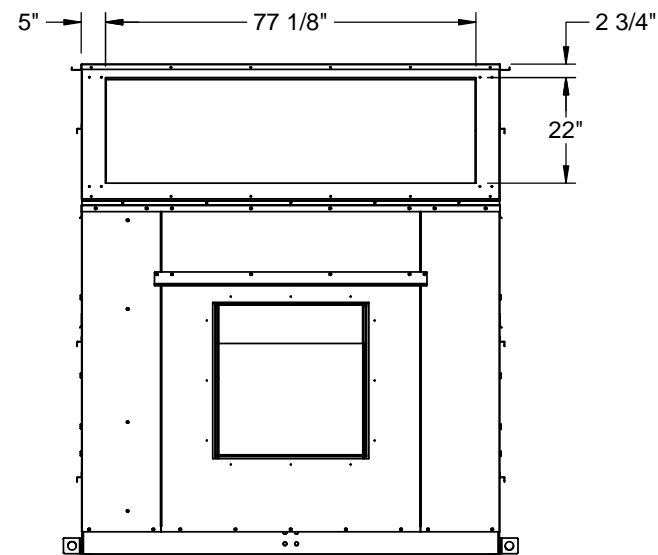

HOOD OMITTED FOR CLARITY

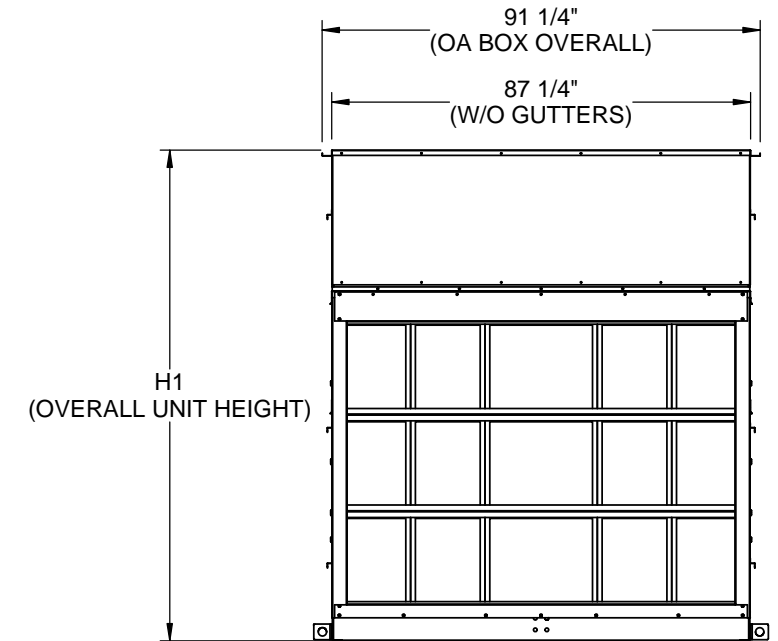
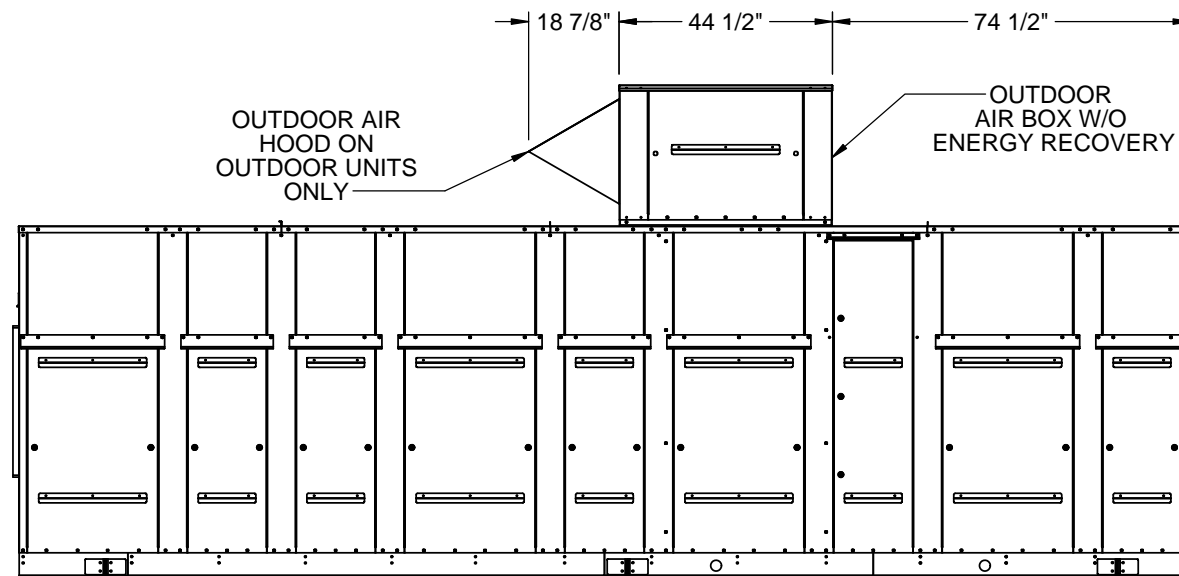

STANDARD OA FILTERS	MODEL SIZE	PART NUMBER	QTY	NOM WIDTH	NOM HEIGHT	NOM DEPTH
DISPOSABLE	35	872-012	2	24	24	4
		870-041	2	20		
	40	872-012	2	24	24	4
		870-041	2	20		
	45	872-012	2	24	24	4
		870-041	2	20		
	50	872-012	2	24	24	4
		870-041	2	20		

Desert Aire has a policy of continuous product and quality improvement. Specifications and dimensions are subject to change without notice. This drawing and information contained herein are the exclusive property of the Desert Aire Corporation. Any use detrimental to the interests of Desert Aire is prohibited.

ALL DIMENSIONS ARE IN INCHES FRACTIONAL TOLERANCE ± 1/8"

All Dimensions in Inches
All Angles 90°
All outside corners 0.125" fillet
Unless Otherwise Specified

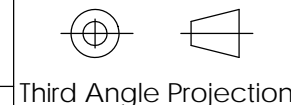

Part weight

Tolerance Unless Otherwise Specified
X.X ±.125
X.XX ±.060
X.XXX ±.030
Angles ±1°



N120 W18485 FREISTADT RD
GERMANTOWN, WI 53022
Tel: (262) 946-7400
Fax: (262) 946-7401

Drawn ASV	Date Released 12/5/2014	Description SA35-50 EXT RETURN w/AUX HEAT
Sheet 3/8	Page Title W/O ENERGY RECOVERY	
Scale NTS	Rev. 0	Drawing Number G900-011



HOODS NOT PROVIDED ON INDOOR UNITS.
NOTE: SOME OUTDOOR CONFIGURATIONS
WILL NOT OVERHANG CABINET.

UNIT TYPE	MODEL SIZE	H1	L2		V	OA BOX										
			INDOOR	OUTDOOR		HOOD(S)		L3	OA INTAKE OPENING				EXHAUST DISCHARGE OPENING			
						K	M		SH	SW	G	J	EH	EW	N	P
ENERGY RECOVERY STANDAR D	35	114	244	244	50	23 3/8	23 3/8	82 3/4	19 1/2	66 1/2	7 1/8	18	20	30	4 1/4	36 1/4
	40	114	244	244	50	23 3/8	23 3/8	82 3/4	19 1/2	66 1/2	7 1/8	18	20	30	4 1/4	36 1/4
	45	129	244	244	50	23 3/8	23 3/8	82 3/4	19 1/2	66 1/2	7 1/8	18	20	30	4 1/4	36 1/4
	50	129	244	244	50	23 3/8	23 3/8	82 3/4	19 1/2	66 1/2	7 1/8	18	20	30	4 1/4	36 1/4
ENERGY RECOVERY EXPANDED BOX	35	114	244	267 3/4	0	13 7/8	23 3/8	157 3/8	33	84	4 1/4	15/8	20	80	4 1/4	35/8
	40	114	244	267 3/4	0	13 7/8	23 3/8	157 3/8	33	84	4 1/4	15/8	20	80	4 1/4	35/8
	45	129	244	267 3/4	0	13 7/8	23 3/8	157 3/8	33	84	4 1/4	15/8	20	80	4 1/4	35/8
	50	129	244	267 3/4	0	13 7/8	23 3/8	157 3/8	33	84	4 1/4	15/8	20	80	4 1/4	35/8

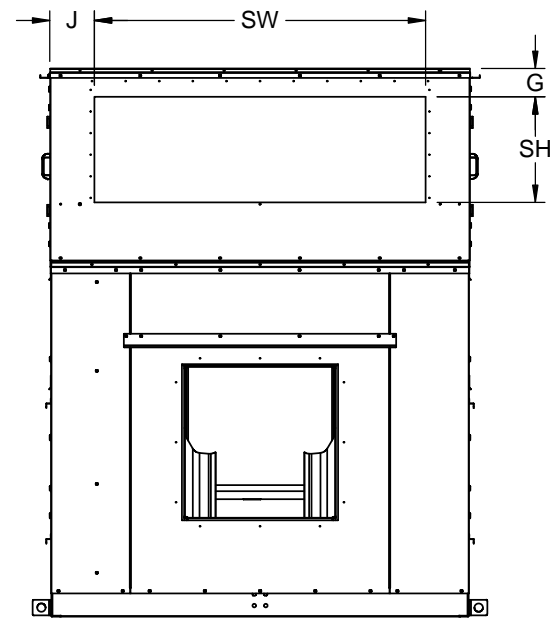

HOODS OMITTED FOR CLARITY

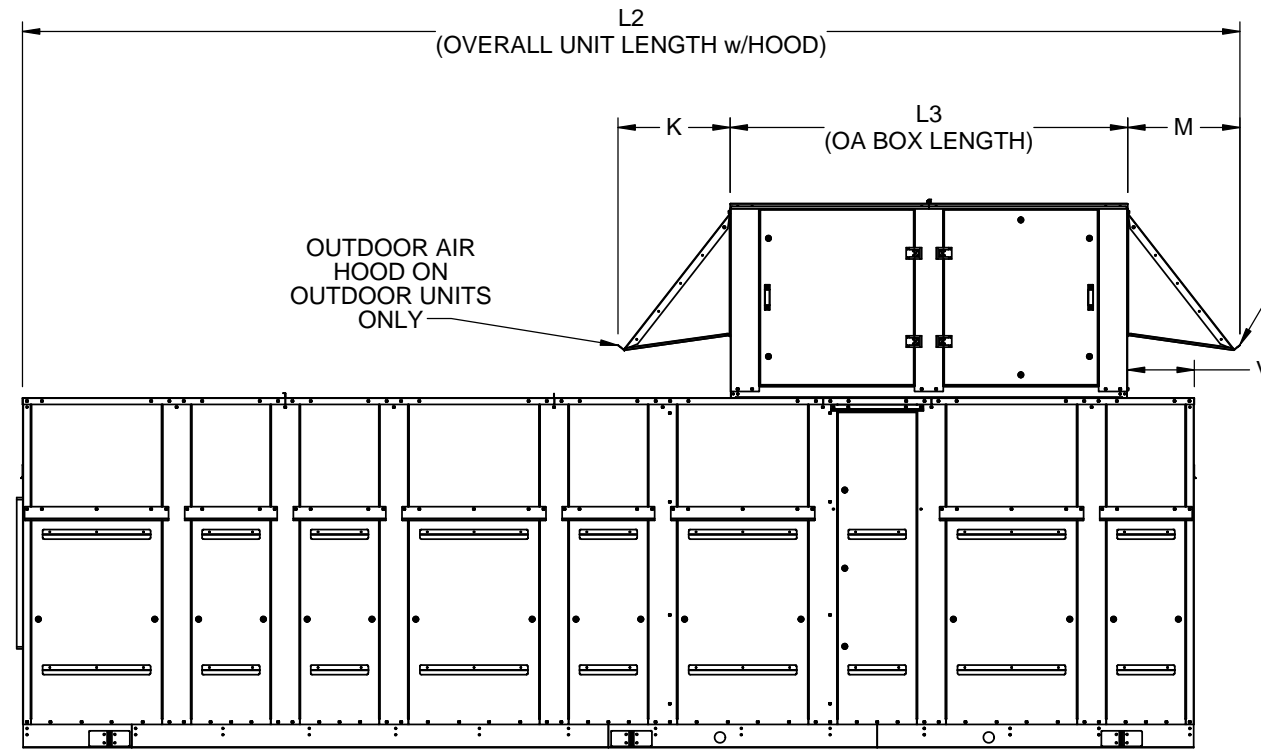

DRAWING IS REPRESENTATIVE
REFER TO TABLES FOR DIMENSIONS OF ACTUAL UNIT SELECTION

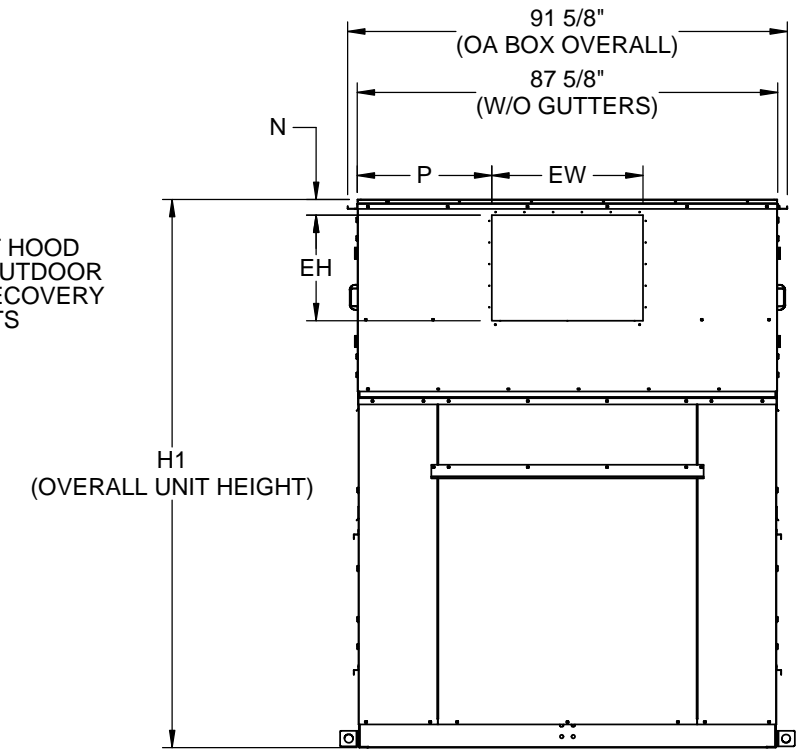

HOODS OMITTED FOR CLARITY

STANDARD OA FILTERS	MODEL SIZE	PART NUMBER	QTY	NOM WIDTH	NOM HEIGHT	NOM DEPTH
DISPOSABLE	35	872-012	2	24	24	4
		870-041	2	20		
	40	872-012	2	24	24	4
		870-041	2	20		
	45	872-012	2	24	24	4
		870-041	2	20		
50	872-012	2	24	24	4	
	870-041	2	20			

EXPANDED OA FILTERS	MODEL SIZE	PART NUMBER	QTY	NOM WIDTH	NOM HEIGHT	NOM DEPTH
DISPOSABLE	35	870-010	2	20	20	4
		870-041	4	20	24	4
		870-012	2	24	24	4
	40	870-010	2	20	20	4
		870-041	4	20	24	4
		870-012	2	24	24	4
	45	870-010	2	20	20	4
		870-041	4	20	24	4
		870-012	2	24	24	4
	50	870-010	2	20	20	4
		870-041	4	20	24	4
		870-012	2	24	24	4

Desert Aire has a policy of continuous product and quality improvement. Specifications and dimensions are subject to change without notice. This drawing and information contained herein are the exclusive property of the Desert Aire Corporation. Any use detrimental to the interests of Desert Aire is prohibited.

ALL DIMENSIONS ARE IN INCHES
FRACTIONAL TOLERANCE ± 1/8"

All Dimensions in Inches
All Angles 90°
All outside corners 0.125" fillet
Unless Otherwise Specified

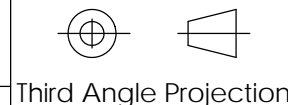

Part weight

Tolerance Unless Otherwise Specified
X.X ±.125
X.XX ±.060
X.XXX ±.030
Angles ±1°



N120 W18485 FREISTADT RD
GERMANTOWN, WI 53022
Tel: (262) 946-7400
Fax: (262) 946-7401

Drawn ASV	Date Released 12/5/2014	Description SA35-50 EXT RETURN w/AUX HEAT
Sheet 4/8	Scale NTS	Page Title W/ ENERGY RECOVERY
Rev. 0	Drawing Number G900-011	

35 TON					40 TON					45 TON					50 TON				
BLOWER	DH1	DW1	R1	Q1	BLOWER	DH1	DW1	R1	Q1	BLOWER	DH1	DW1	R1	Q1	BLOWER	DH1	DW1	R1	Q1
ATLI 18-18	18 7/8	22 1/8	17 3/8	32 5/8	ATLI 18-18	18 7/8	22 1/8	17 3/8	32 5/8	ATLI 18-18	18 7/8	22 1/8	17 3/8	32 5/8	ATLI 22-22	28 1/4	28 1/4	18 7/8	29 5/8
ATLI 20-15	25 1/4	20 1/4	17 3/8	33 5/8	ATLI 20-15	25 1/4	20 1/4	17 3/8	33 5/8	ATLI 20-15	25 1/4	20 1/4	17 3/8	33 5/8	ATLI 25-25	31 3/4	31 3/4	20 3/8	27 7/8
ATZAF 22-22	28 1/4	28 1/4	18 7/8	29 5/8	ATZAF 22-22	28 1/4	28 1/4	18 7/8	29 5/8	ATZAF 25-25	31 3/4	31 3/4	20 3/8	27 7/8	ATZAF 25-25	31 3/4	31 3/4	20 3/8	27 7/8
ATZAF 25-25	31 3/4	31 3/4	20 3/8	27 7/8	ATZAF 25-25	31 3/4	31 3/4	20 3/8	27 7/8	ATZAF 28-28	35 1/2	35 1/2	22 3/8	26	ATZAF 28-28	35 1/2	35 1/2	22 3/8	26
ATZAF 28-28	35 1/2	35 1/2	22 3/8	26	ATZAF 28-28	35 1/2	35 1/2	22 3/8	26										

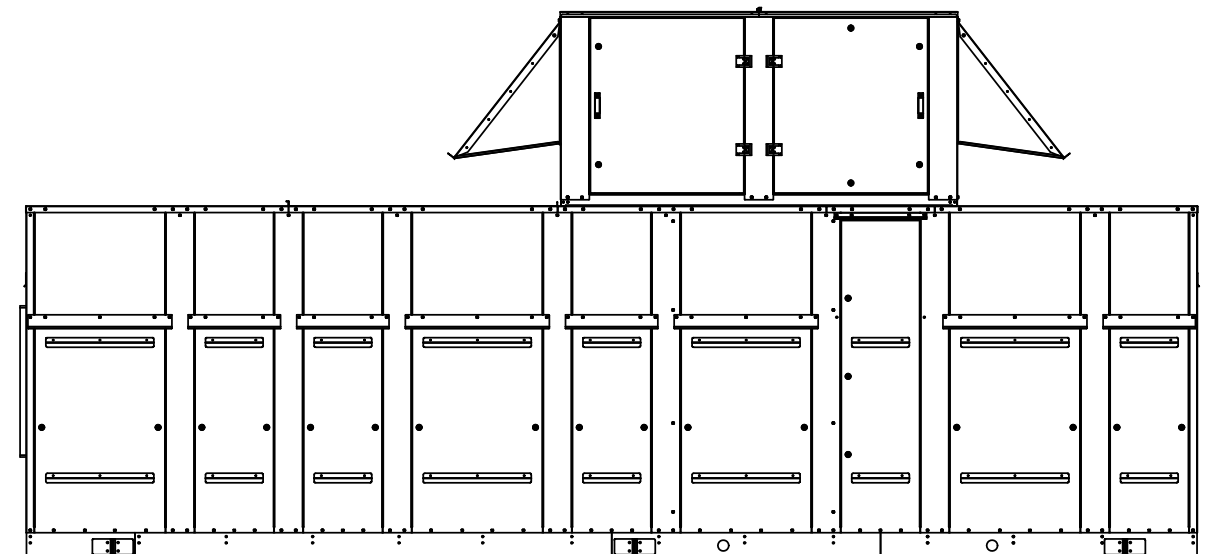
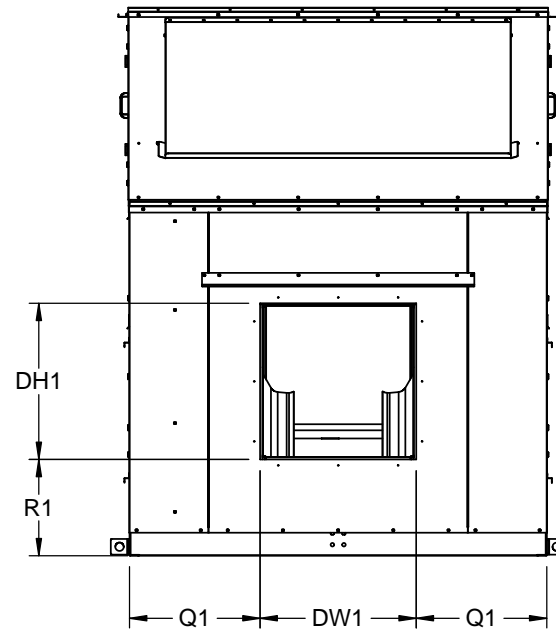
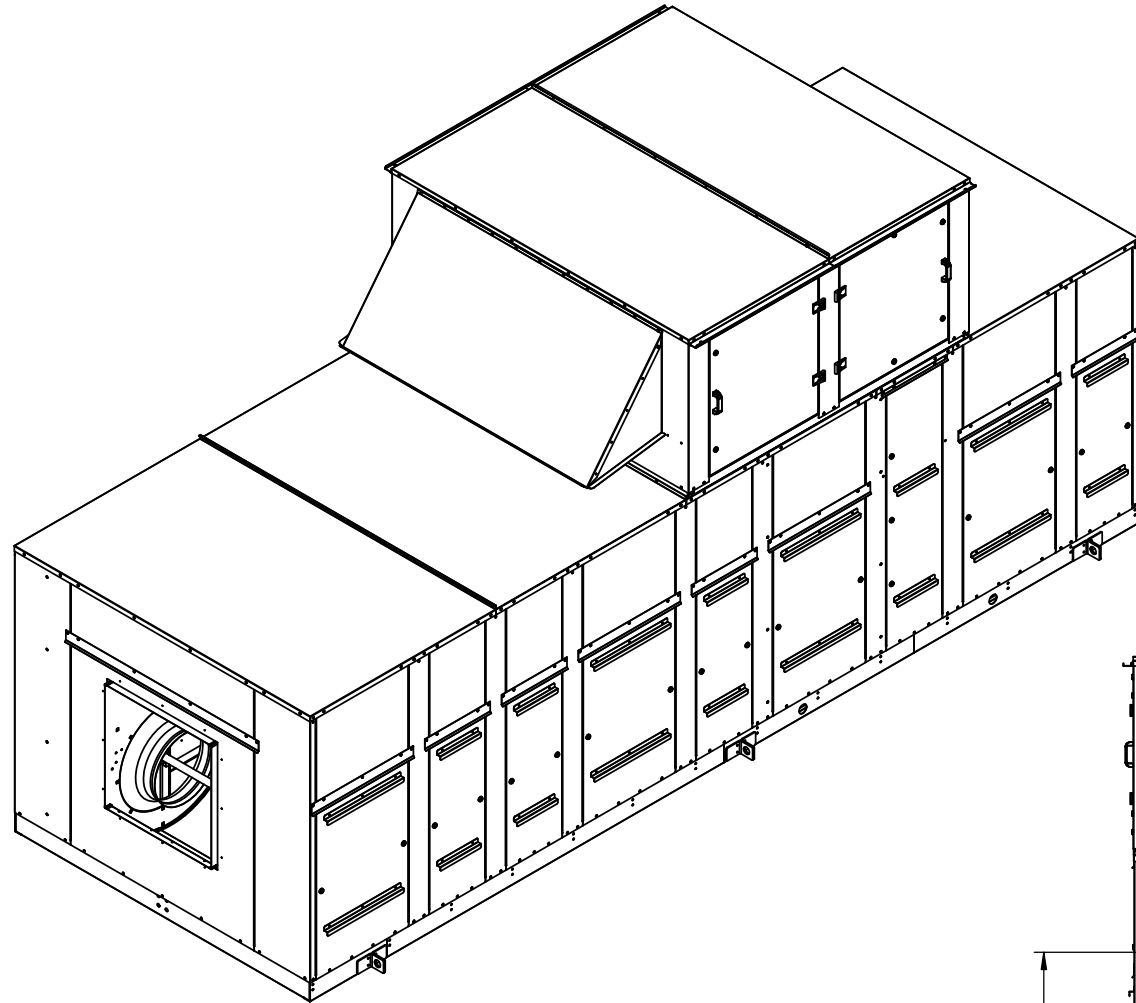

Desert Aire has a policy of continuous product and quality improvement. Specifications and dimensions are subject to change without notice. This drawing and information contained herein are the exclusive property of the Desert Aire Corporation. Any use detrimental to the interests of Desert Aire is prohibited.

ALL DIMENSIONS ARE IN INCHES
FRACTIONAL TOLERANCE ± 1/8"

All Dimensions in Inches
All Angles 90°
All outside corners 0.125" fillet
Unless Otherwise Specified



Third Angle Projection

Part weight

Tolerance Unless
Otherwise Specified
X.X ±.125
X.XX ±.060
X.XXX ±.030
Angles ±1°



N120 W18485 FREISTADT RD
GERMANTOWN, WI 53022
Tel: (262) 946-7400
Fax: (262) 946-7401

Drawn ASV	Date Released 12/5/2014	Description SA35-50 EXT RETURN w/AUX HEAT
Sheet 5/8	Page Title END SUPPLY	
Scale NTS	Rev. 0	Drawing Number G900-011

35 TON						40 TON						45 TON						50 TON											
BLOWER	DH2	DW2	R2		Q2	BLOWER	DH2	DW2	R2		Q2	BLOWER	DH2	DW2	R2		Q2	BLOWER	DH2	DW2	R2		Q2						
			OVER	AWAY					OVER	AWAY					OVER	AWAY					OVER	AWAY							
ATLI 18-18	18 7/8	22 1/8	2 1/8	11 7/8	32 5/8	ATLI 18-18	18 7/8	22 1/8	2 1/8	11 7/8	32 5/8	ATLI 18-18	18 7/8	22 1/8	2 1/8	11 7/8	32 5/8	ATLI 22-22	28 1/4	28 1/4	1 3/8	13 3/8	29 5/8	ATLI 22-22	28 1/4	28 1/4	1 3/8	13 3/8	29 5/8
ATLI 20-15	25 1/4	20 1/4	1 3/8	11 7/8	33 5/8	ATLI 20-15	25 1/4	20 1/4	1 3/8	11 7/8	33 5/8	ATLI 20-15	25 1/4	20 1/4	1 3/8	11 7/8	33 5/8	ATLI 25-25	31 3/4	31 3/4	1 3/8	14 7/8	27 7/8	ATLI 25-25	31 3/4	31 3/4	1 3/8	14 7/8	27 7/8
ATZAF 22-22	28 1/4	28 1/4	1 3/8	13 3/8	29 5/8	ATZAF 22-22	28 1/4	28 1/4	1 3/8	13 3/8	29 5/8	ATZAF 22-22	28 1/4	28 1/4	1 3/8	13 3/8	29 5/8	ATZAF 25-25	31 3/4	31 3/4	1 3/8	14 7/8	27 7/8	ATZAF 25-25	31 3/4	31 3/4	1 3/8	14 7/8	27 7/8
ATZAF 25-25	31 3/4	31 3/4	1 3/8	14 7/8	27 7/8	ATZAF 25-25	31 3/4	31 3/4	1 3/8	14 7/8	27 7/8	ATZAF 25-25	31 3/4	31 3/4	1 3/8	14 7/8	27 7/8	ATZAF 28-28	35 1/2	35 1/2	1 3/8	16 7/8	26	ATZAF 28-28	35 1/2	35 1/2	1 3/8	16 7/8	26
ATZAF 28-28	35 1/2	35 1/2	1 3/8	16 7/8	26	ATZAF 28-28	35 1/2	35 1/2	1 3/8	16 7/8	26	ATZAF 28-28	35 1/2	35 1/2	1 3/8	16 7/8	26												

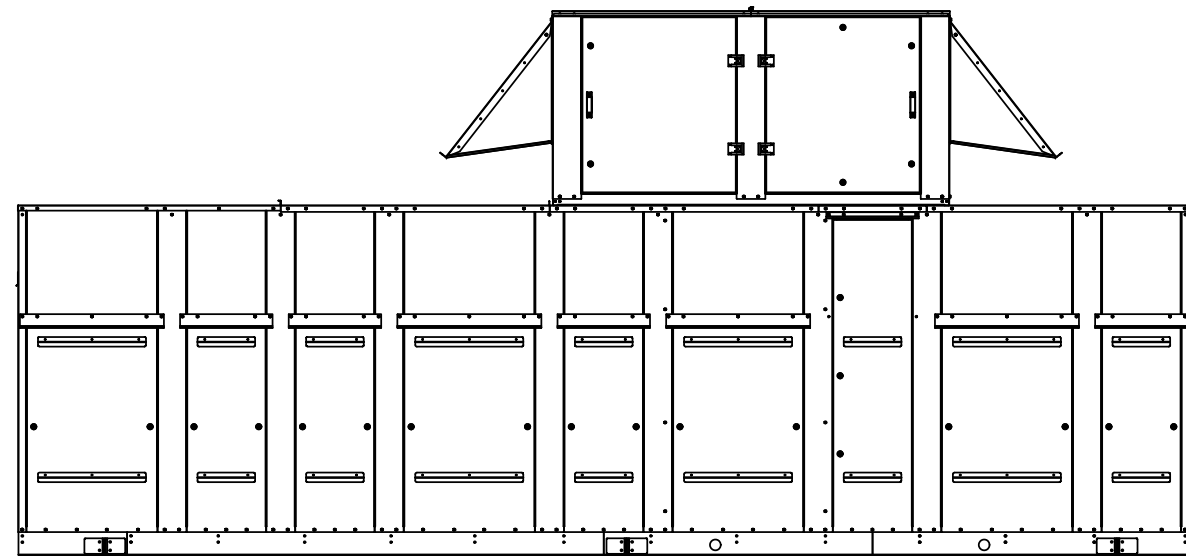
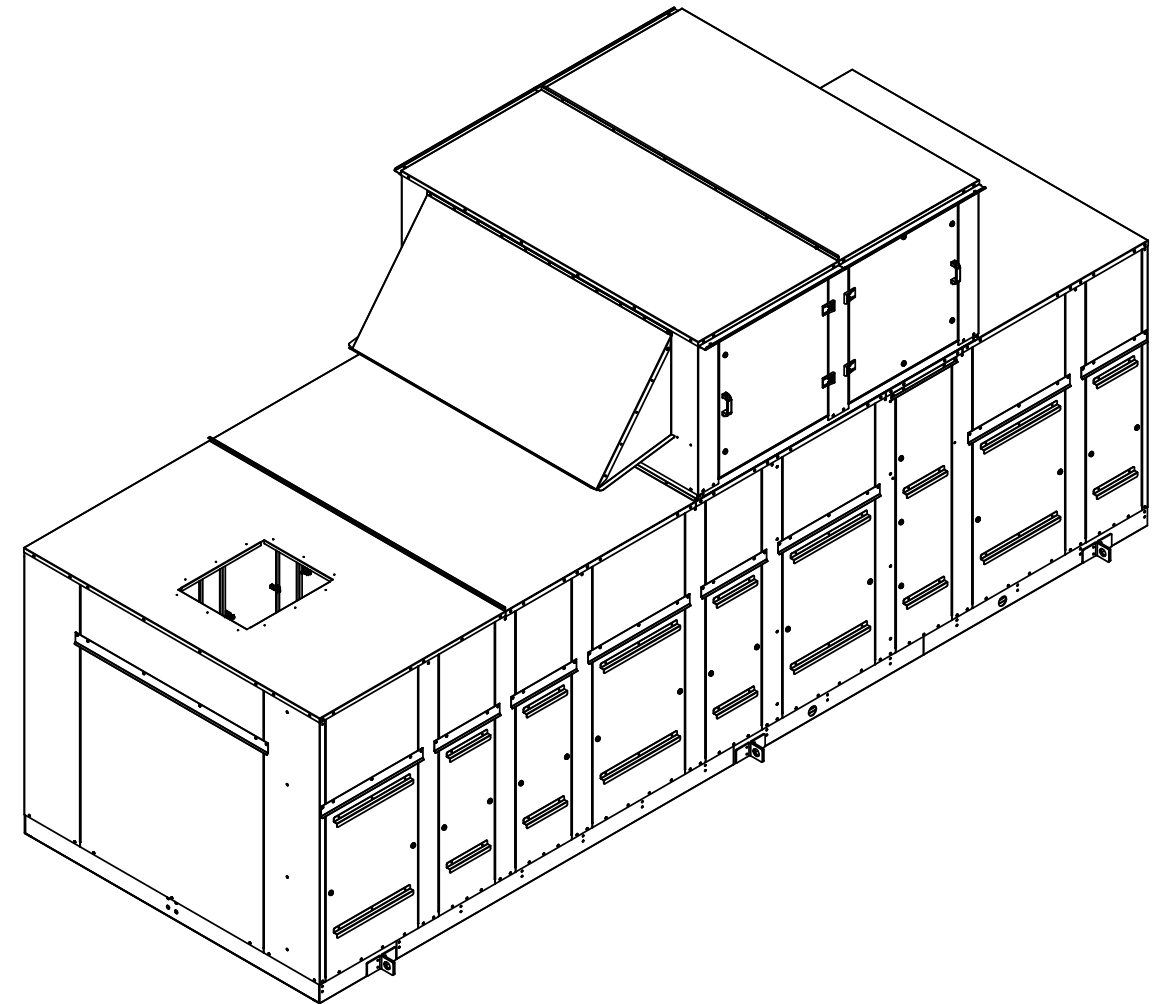
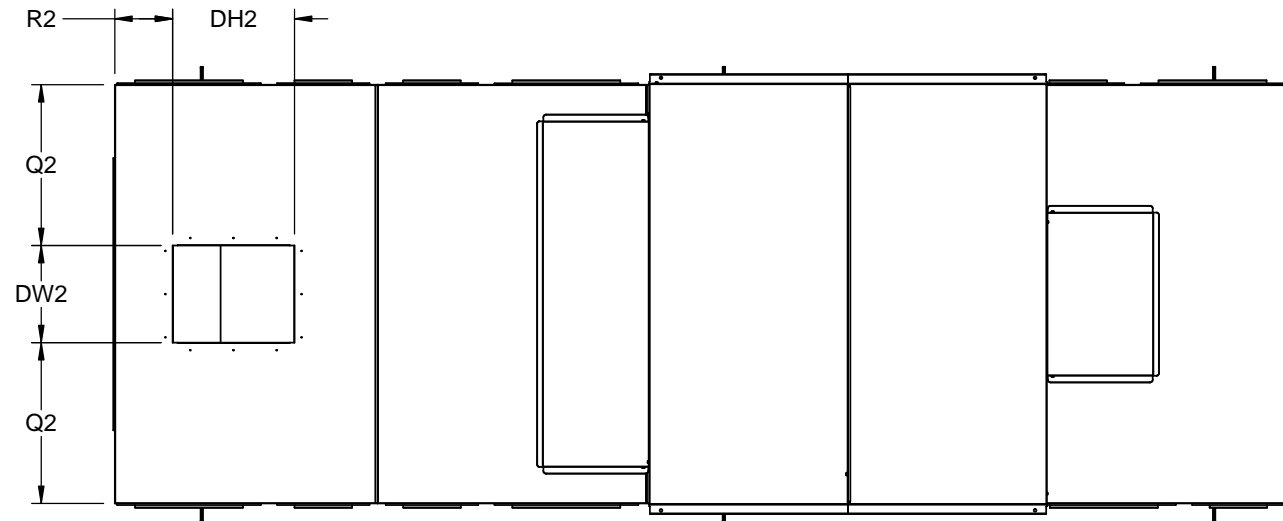

Desert Aire has a policy of continuous product and quality improvement. Specifications and dimensions are subject to change without notice. This drawing and information contained herein are the exclusive property of the Desert Aire Corporation. Any use detrimental to the interests of Desert Aire is prohibited.

ALL DIMENSIONS ARE IN INCHES
FRACTIONAL TOLERANCE ± 1/8"

All Dimensions in Inches
All Angles 90°
All outside corners 0.125" fillet
Unless Otherwise Specified



Third Angle Projection

Part weight

Tolerance Unless Otherwise Specified
X.X ±.125
X.XX ±.060
X.XXX ±.030
Angles ±1°



N120 W18485 FREISTADT RD
GERMANTOWN, WI 53022
Tel: (262) 946-7400
Fax: (262) 946-7401

Drawn ASV	Date Released 12/5/2014	Description SA35-50 EXT RETURN w/AUX HEAT
Sheet 6/8	Page Title TOP SUPPLY	Drawing Number G900-011
Scale NTS	Rev. 0	

35 TON					40 TON					45 TON					50 TON				
BLOWER	DH3	DW3	R3	Q3	BLOWER	DH3	DW3	R3	Q3	BLOWER	DH3	DW3	R3	Q3	BLOWER	DH3	DW3	R3	Q3
ATLI 18-18	18 7/8	22 1/8	11 7/8	32 5/8	ATLI 18-18	18 7/8	22 1/8	11 7/8	32 5/8	ATLI 18-18	18 7/8	22 1/8	11 7/8	32 5/8	ATLI 22-22	28 1/4	28 1/4	13 3/8	29 5/8
ATLI 20-15	25 1/4	20 1/4	11 7/8	33 5/8	ATLI 20-15	25 1/4	20 1/4	11 7/8	33 5/8	ATLI 20-15	25 1/4	20 1/4	11 7/8	33 5/8	ATLI 25-25	31 3/4	31 3/4	14 7/8	27 7/8
ATZAF 22-22	28 1/4	28 1/4	13 3/8	29 5/8	ATZAF 22-22	28 1/4	28 1/4	13 3/8	29 5/8	ATZAF 25-25	31 3/4	31 3/4	14 7/8	27 7/8	ATZAF 25-25	31 3/4	31 3/4	14 7/8	27 7/8
ATZAF 25-25	31 3/4	31 3/4	14 7/8	27 7/8	ATZAF 25-25	31 3/4	31 3/4	14 7/8	27 7/8	ATZAF 28-28	35 1/2	35 1/2	16 7/8	26	ATZAF 28-28	35 1/2	35 1/2	16 7/8	26
ATZAF 28-28	35 1/2	35 1/2	16 7/8	26	ATZAF 28-28	35 1/2	35 1/2	16 7/8	26										

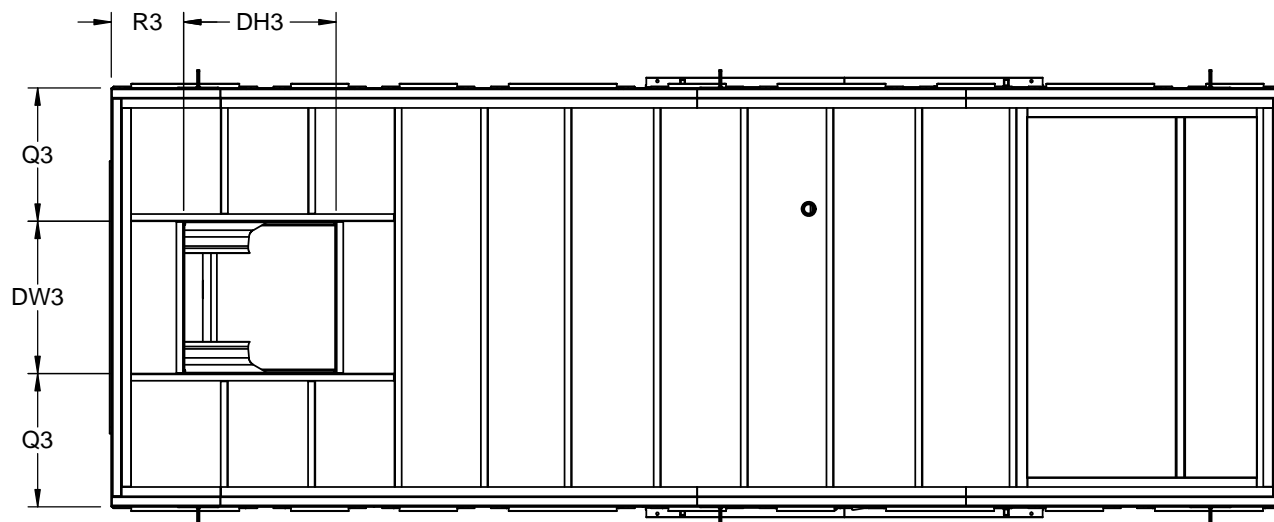
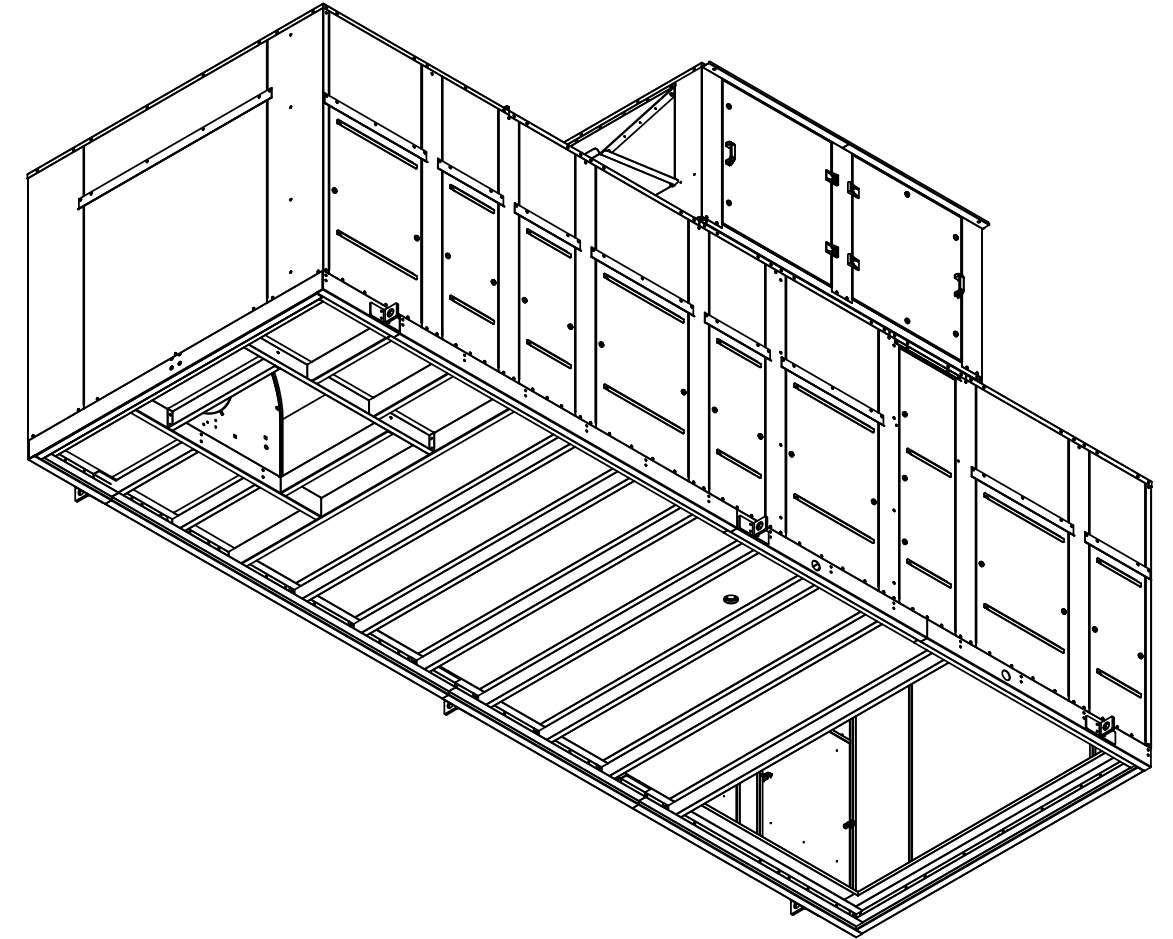
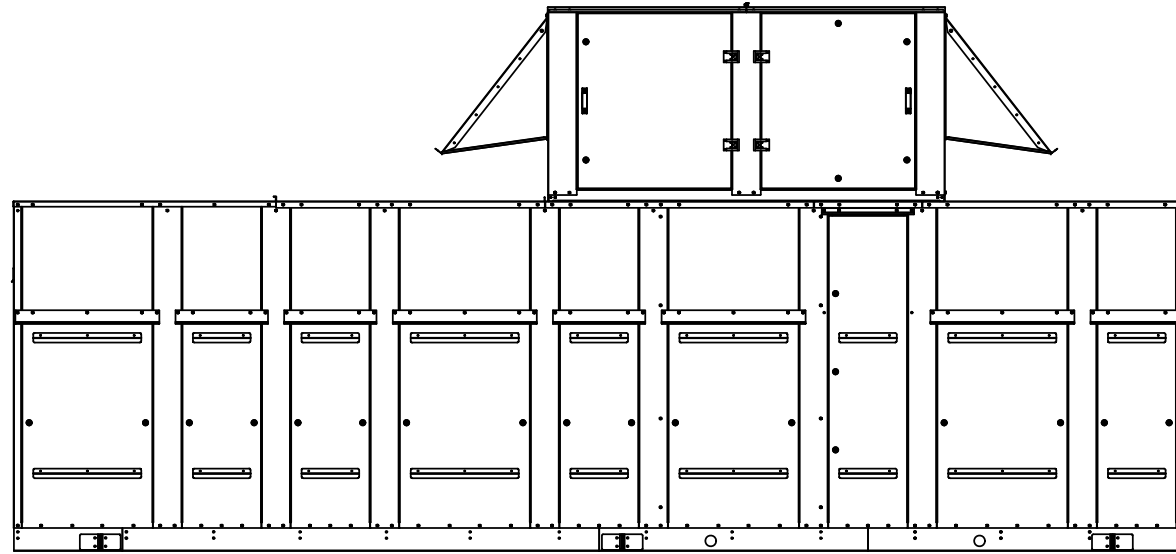

Desert Aire has a policy of continuous product and quality improvement. Specifications and dimensions are subject to change without notice. This drawing and information contained herein are the exclusive property of the Desert Aire Corporation. Any use detrimental to the interests of Desert Aire is prohibited.	All Dimensions in Inches All Angles 90° All outside corners 0.125" fillet Unless Otherwise Specified	Tolerance Unless Otherwise Specified X.X ±.125 X.XX ±.060 X.XXX ±.030 Angles ±1°	N120 W18485 FREISTADT RD GERMANTOWN, WI 53022 Tel: (262) 946-7400 Fax: (262) 946-7401
ALL DIMENSIONS ARE IN INCHES FRACTIONAL TOLERANCE ± 1/8"	Third Angle Projection	Sheet: 7/8 Scale: NTS	Page Title: DOWN SUPPLY Rev. Number: 0 Drawing Number: G900-011

G900-011

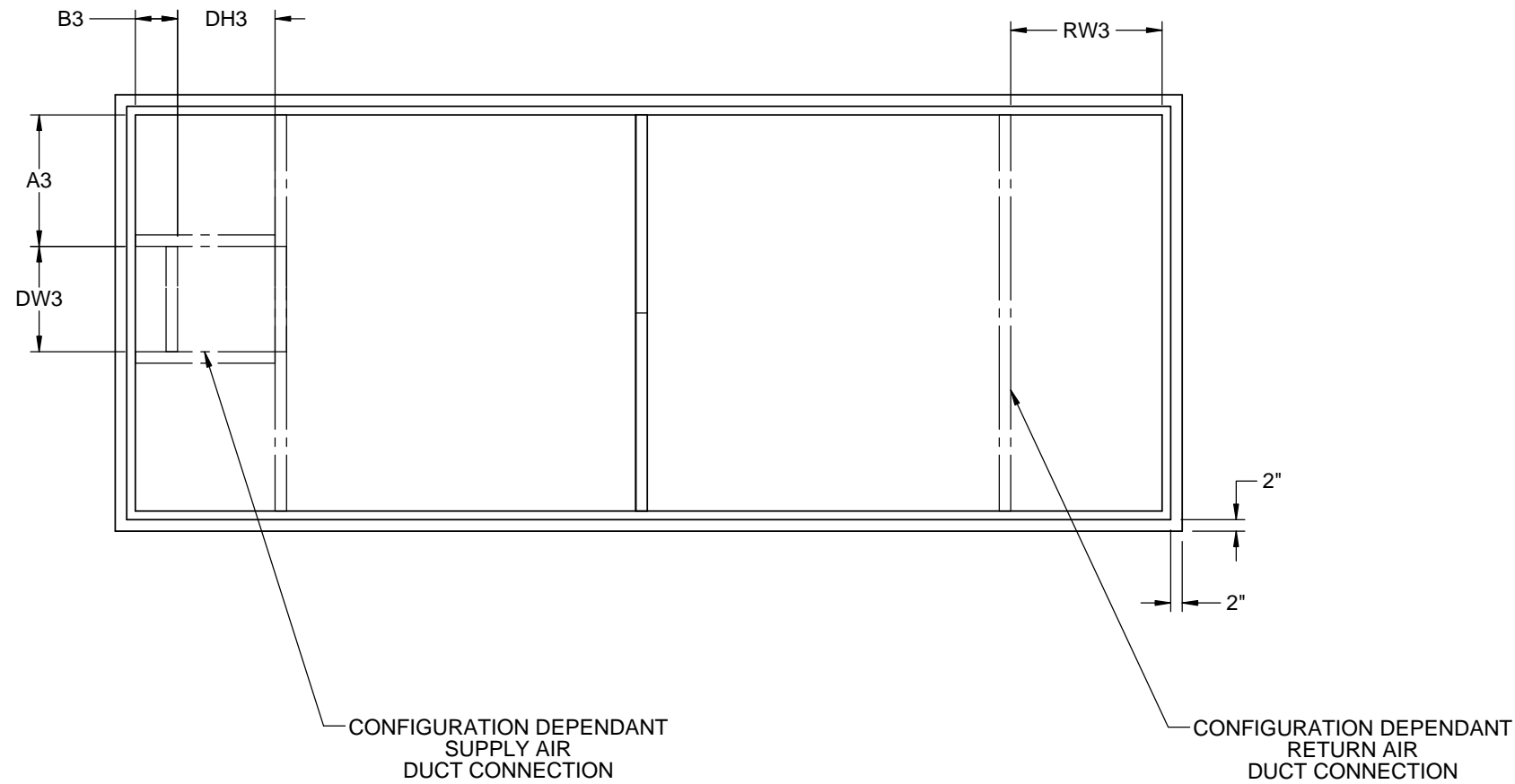

CURB PN	CURB		DOWN SUPPLY AND / OR DOWN RETURN				
	LENGTH	WIDTH	RW3	DW3	A3	DH3	B3
CB-MNGC-XX	238 7/8	82	51 3/8	22 1/8	28 1/2	18 7/8	7 7/8
CB-MNGD-XX	238 7/8	82	51 3/8	20 1/4	29 3/8	25 1/4	7 7/8
CB-MNGE-XX	238 7/8	82	51 3/8	28 1/4	25 3/8	28 1/4	9 3/8
CB-MNGF-XX	238 7/8	82	51 3/8	31 3/4	23 5/8	31 3/4	10 7/8
CB-MNGJ-XX	238 7/8	82	51 3/8	28 1/4	25 3/8	28 1/4	9 3/8
CB-MNGK-XX	238 7/8	82	51 3/8	31 3/4	23 5/8	31 3/4	10 7/8
CB-MNGM-XX	238 7/8	82	51 3/8	35 1/2	21 3/4	35 1/2	12 7/8
CB-MNGZ-XX	238 7/8	82	51 3/8	NO SUPPLY/RETURN DUCT CONNECITON			

CURB HEIGHT IN INCHES DESIGNATED BY XX IN THE CURB PART NUMBER

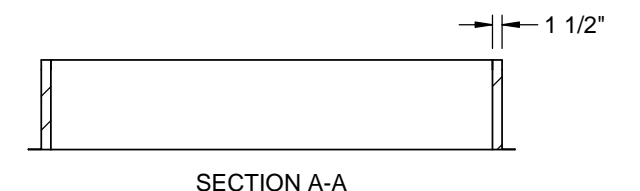
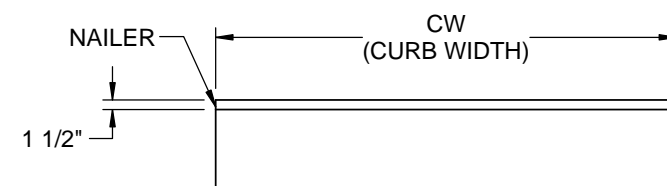
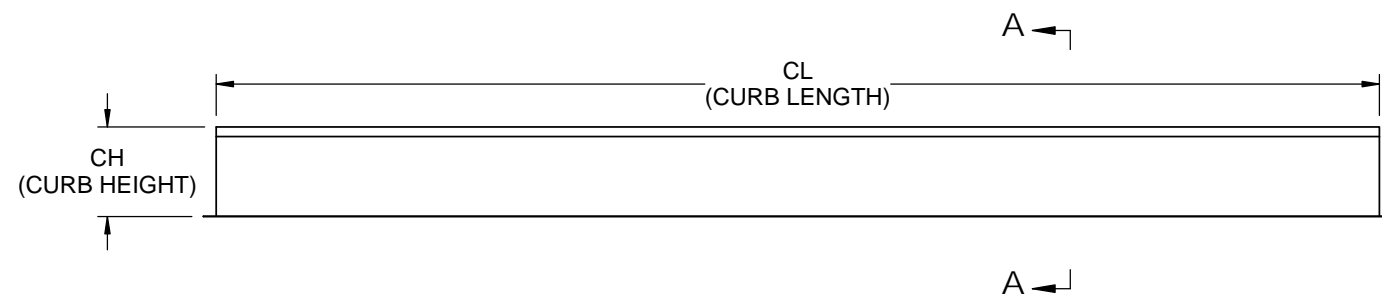

DUCT CONNECTIONS FOR DOWN SUPPLY AND/OR DOWN RETURN

NOTES:
REFER TO SHEET 1 FOR GENERAL NOTES

CURBS 115" IN LENGTH AND LESS ARE SHIPPED AS COMPLETE CURBS, GREATER THAN 115" ARE SHIPPED KNOCKED DOWN.

NUMBER AND LOCATION OF CROSS SUPPORT(S) IS DEPENDANT UPON THE GAUGE OF MATERIAL USED TO CONSTRUCT THE CURB, DUCT SUPPORT CONFIGURATION, LENGTH OF CURB, AND WIDTH OF CURB. INSTALLATION INSTRUCTIONS INCLUDED WITH CURB SHIPMENT INDICATE THE REQUIRED POSITION FOR FIELD ASSEMBLED CURBS.

Desert Aire has a policy of continuous product and quality improvement. Specifications and dimensions are subject to change without notice. This drawing and information contained herein are the exclusive property of the Desert Aire Corporation. Any use detrimental to the interests of Desert Aire is prohibited.	All Dimensions in Inches All Angles 90° All outside corners 0.125" fillet Unless Otherwise Specified	Tolerance Unless Otherwise Specified X.X ±.125 X.XX ±.060 X.XXX ±.030 Angles ±1°	N120 W18485 FREISTADT RD GERMANTOWN, WI 53022 Tel: (262) 946-7400 Fax: (262) 946-7401
ALL DIMENSIONS ARE IN INCHES TOLERANCE ± 1/8"	Third Angle Projection	Sheet: 8/8	Page Title: CURB DETAILS
Part weight	Scale: NTS	Rev. 0	Drawing Number: G900-011