

G900-006

NON-VENTILATION UNIT SHOWN

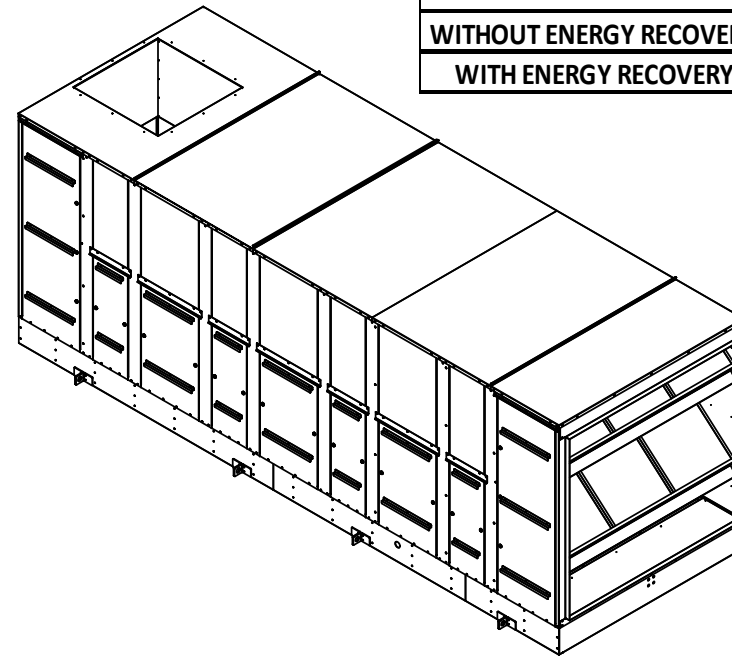
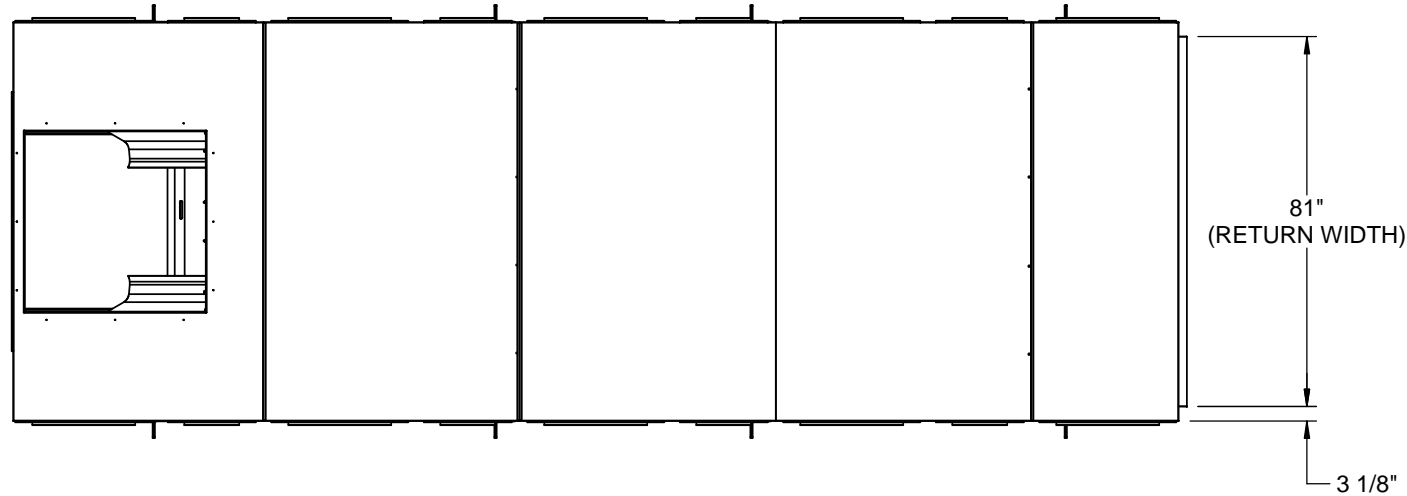

UNIT TYPE	MODEL SIZE	RL	L1	UH	H2	H3
WITHOUT ENERGY RECOVERY	60	254 5/8	256 3/4	94 7/8	74	13 5/8
WITH ENERGY RECOVERY	60	254 5/8	256 3/4	94 7/8	74	13 5/8

FILTER OPTION	MODEL SIZE	PART NUMBER	QTY	NOM WIDTH	NOM HEIGHT	NOM DEPTH
DISPOSABLE	60	870-030	12	16	25	4
		870-079	8	20		
DEACTIVATOR	60	872-008	12	25	29	2
		870-073	12			

SEE OA OPTIONS
PAGE(S) FOR DETAILS

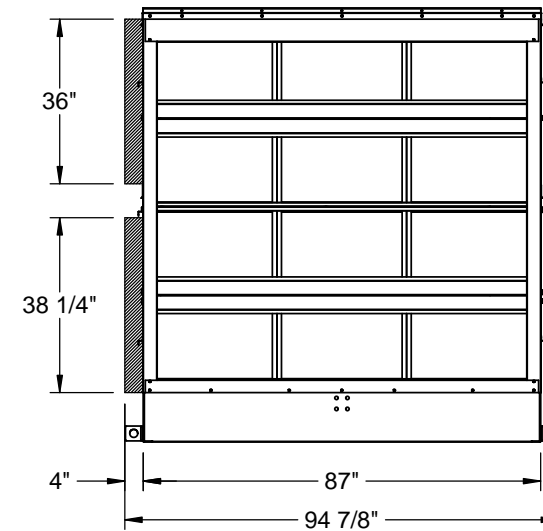
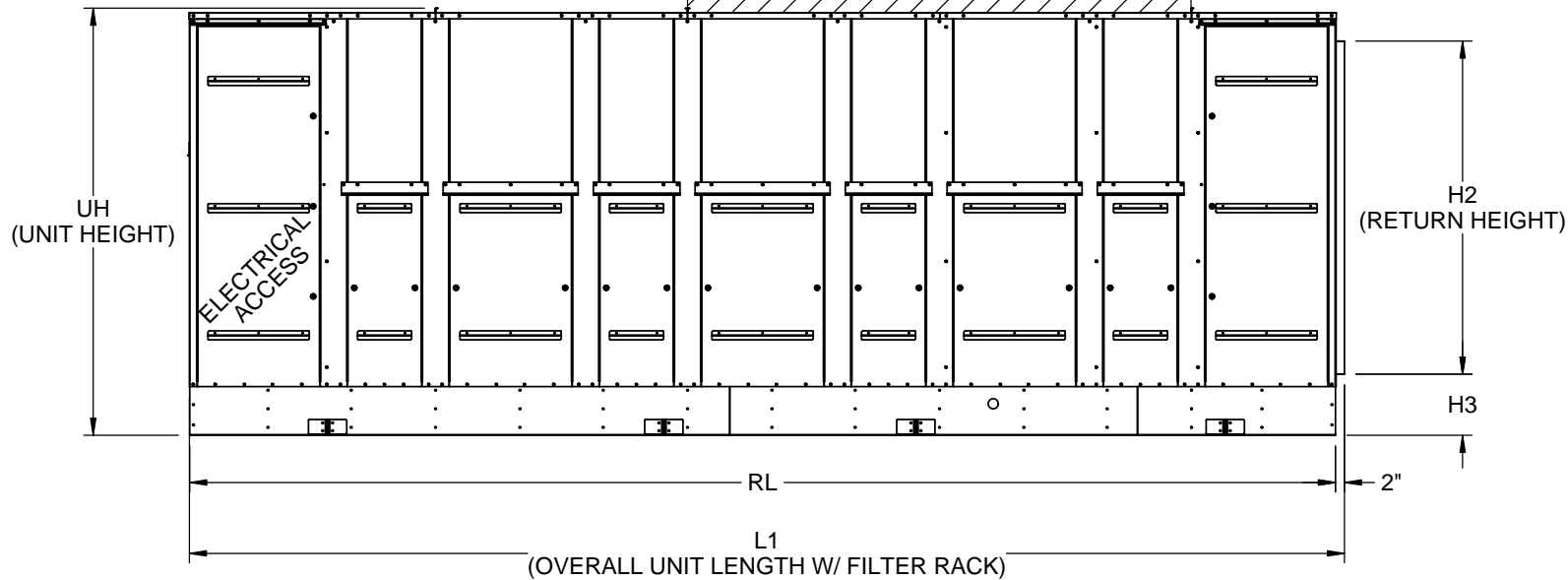

OPTIONAL OUTDOOR HOODS OMITTED FOR CLARITY
SEE OA BOX OPTION PAGES FOR DETAILED INFORMATION

GENERAL NOTES FOR APPLICABLE SHEETS:

VIEWS ARE FOR PICTORAL PURPOSES.

REFER TO SUBMITTAL FOR CUSTOMER CONNECTION LOCATIONS.

DIMENSIONS ARE TO ACCESS SIDE OF UNIT.

LH ACCESS SHOWN FOR DISPLAY PURPOSES. ACCESS DOOR CONFIGURATION MAY CHANGE DEPENDING ON UNIT SIZE OR TYPE
REFER TO SHEET 4,5,6 FOR INTAKE AND DISCHARGE CONNECTION DIMENSIONS.

Desert Aire has a policy of continuous product and quality improvement. Specifications and dimensions are subject to change without notice. This drawing and information contained herein are the exclusive property of the Desert Aire Corporation. Any use detrimental to the interests of Desert Aire is prohibited.

All Dimensions in Inches
All Angles 90°
All outside corners 0.125" fillet
Unless Otherwise Specified

Tolerance Unless Otherwise Specified
X.X ±.125
X.XX ±.060
X.XXX ±.030
Angles ±1°



N120 W18485 FREISTADT RD
GERMANTOWN, WI 53022
Tel: (262) 946-7400
Fax: (262) 946-7401

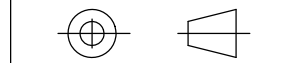

Part weight

Drawn ASV	Date Released 12/5/2014	Description SA60 STD RETURN W/AUX HEAT
Sheet 1/7	Page Title GENERAL INFORMATION	
Scale NTS	Rev. 0	Drawing Number G900-006

ALL DIMENSIONS ARE IN INCHES
FRACTIONAL TOLERANCE ± 1/8"

G900-006

ENERGY RECOVERY OPTION SHOWN

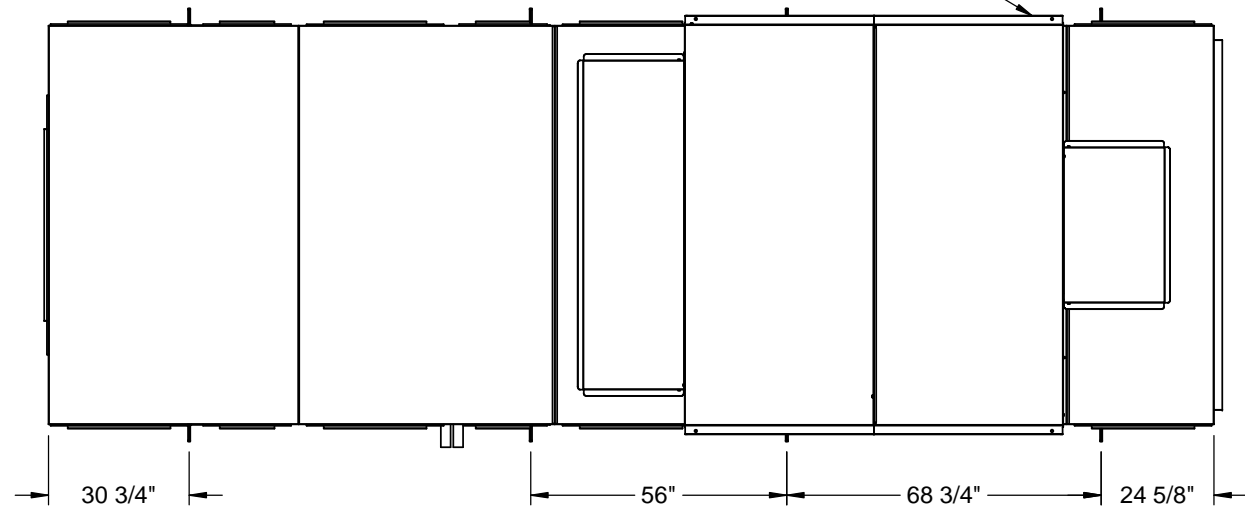

UNIT TYPE	MODEL SIZE	POOL WATER		CIRCUIT A		CIRCUIT B	
		CIRCUIT A	CIRCUIT B	DISCH DIA	LIQUID DIA	DISCH DIA	LIQUID DIA
WITHOUT ENERGY RECOVERY	60	2	2	1 5/8	1 1/8	1 5/8	1 1/8
WITH ENERGY RECOVERY	60	2	2	1 5/8	1 1/8	1 5/8	1 1/8

OPTIONAL HOT WATER/STEAM SIDE CONNECTION LOCATION

OPTIONAL SIDE REMOTE CONDENSER CONNECTION LOCATION

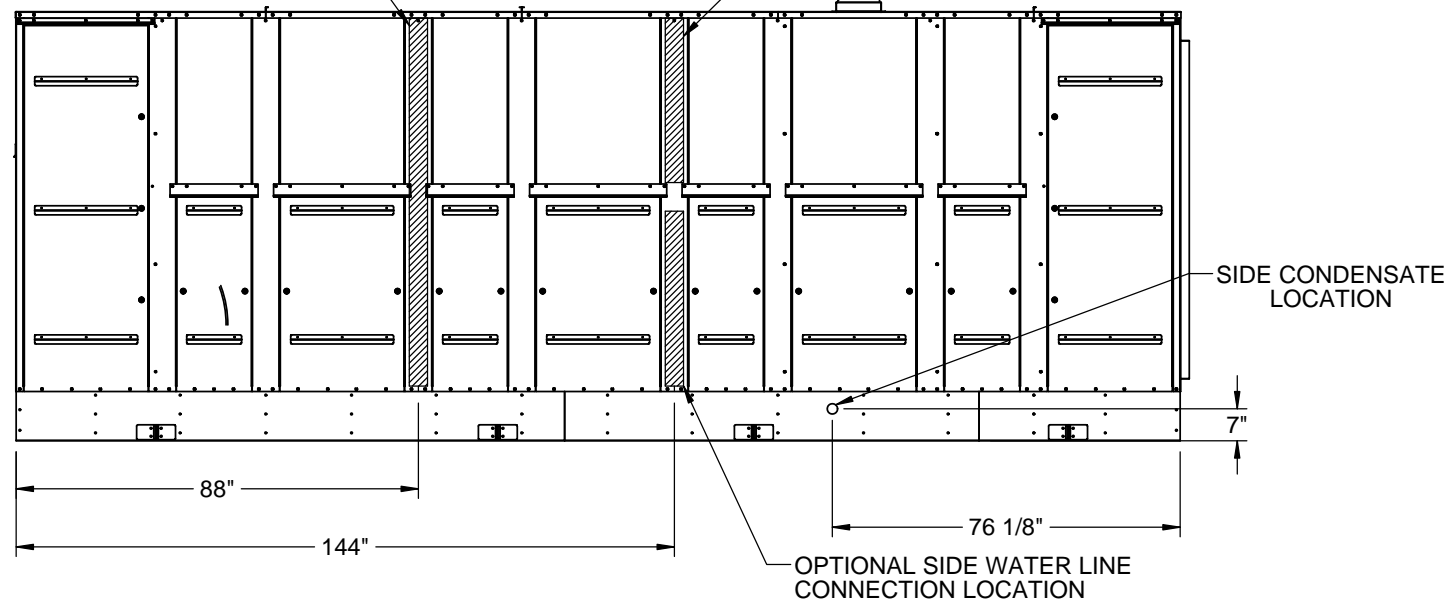

DUCT CONNECTION w/DAMPER OPTION SHOWN

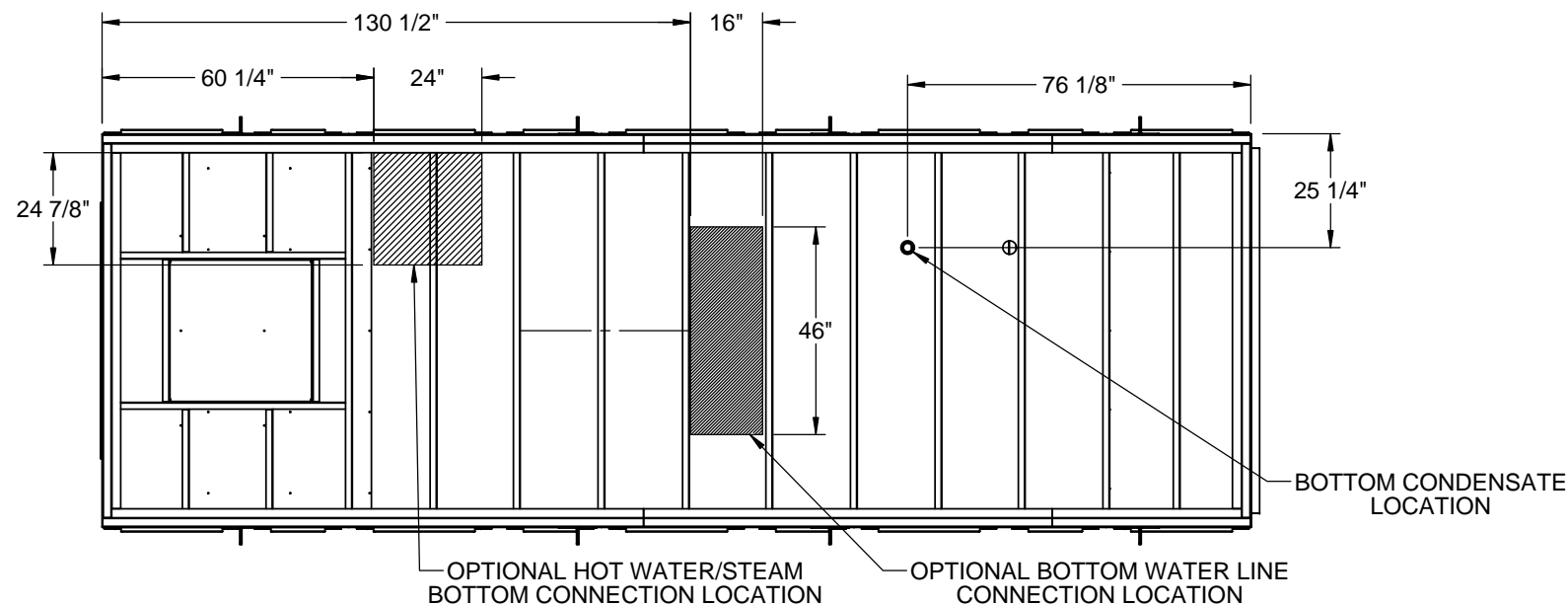
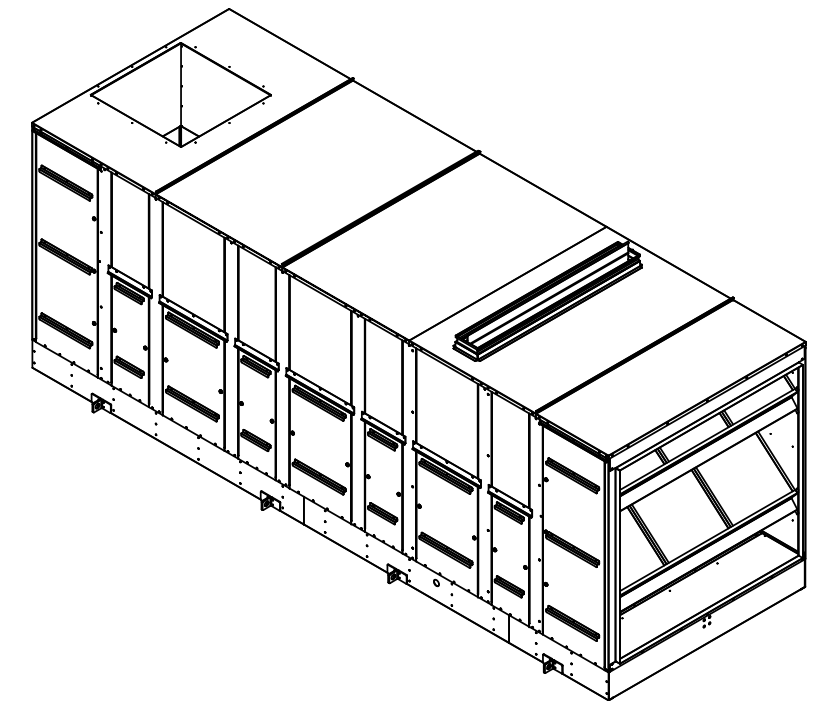
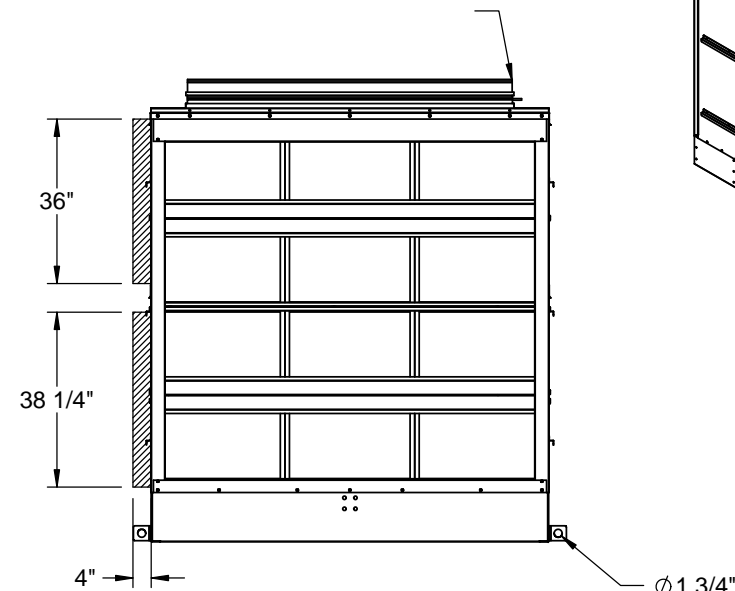

LEFT HAND CONNECTION OPTIONS SHOWN
RIGHT HAND CONNECTION OPTIONS LOCATED WITH SAME DIMENSIONS OPPOSITE SIDE WHEN SPECIFIED

Desert Aire has a policy of continuous product and quality improvement. Specifications and dimensions are subject to change without notice. This drawing and information contained herein are the exclusive property of the Desert Aire Corporation. Any use detrimental to the interests of Desert Aire is prohibited.	All Dimensions in Inches All Angles 90° All outside corners 0.125" fillet Unless Otherwise Specified	Tolerance Unless Otherwise Specified X.X ±.125 X.XX ±.060 X.XXX ±.030 Angles ±1°	N120 W18485 FREISTADT RD GERMANTOWN, WI 53022 Tel: (262) 946-7400 Fax: (262) 946-7401
ALL DIMENSIONS ARE IN INCHES FRACTIONAL TOLERANCE ± 1/8"	Third Angle Projection	Sheet 2/7	Page Title CUSTOMER CONNECTIONS
Part weight	Scale NTS	Rev. 0	Drawing Number G900-006

① HOODS NOT PROVIDED ON INDOOR UNITS.
NOTE: SOME OUTDOOR CONFIGURATIONS
WILL NOT OVERHANG CABINET.

UNIT TYPE	MODEL SIZE	H1			L2 ①		V	OA BOX					
		NO VENTILATION	DUCT CONNECTION	OA BOX	INDOOR	OUTDOOR		HOOD(S)		L3	OUTDOOR OVERALL	W2	W1
								K	M				
WITHOUT ENERGY RECOVERY	60	94 7/8	98 1/4	123 1/4	256 3/4	256 3/4	54 1/8	18 7/8	N/A	44 1/2	63 3/8	87 1/8	91 3/8
WITH ENERGY RECOVERY	60	N/A	N/A	135 1/4	256 3/4	256 3/4	33	23 3/8	23 3/8	82 3/4	129 5/8	87 1/8	91 3/4

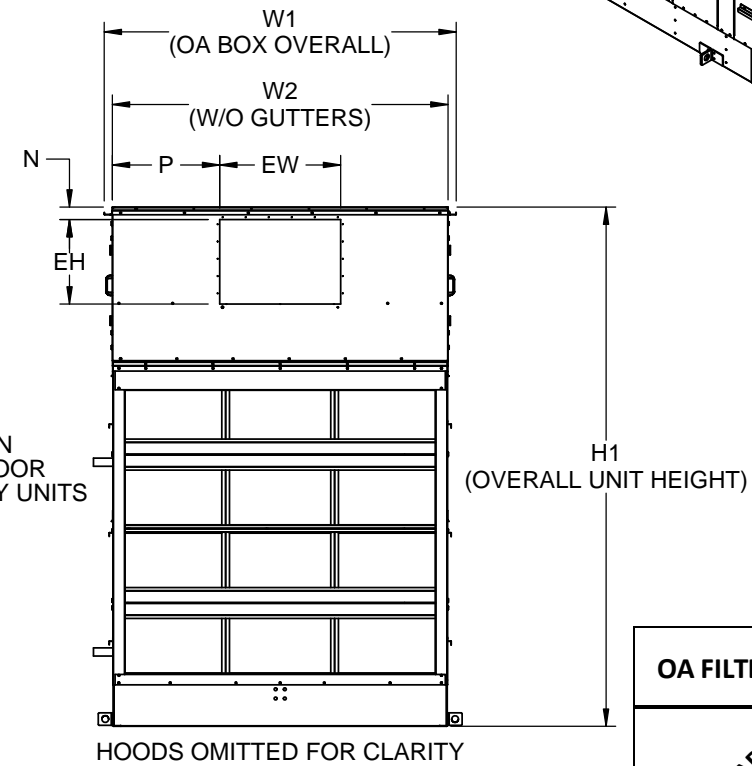
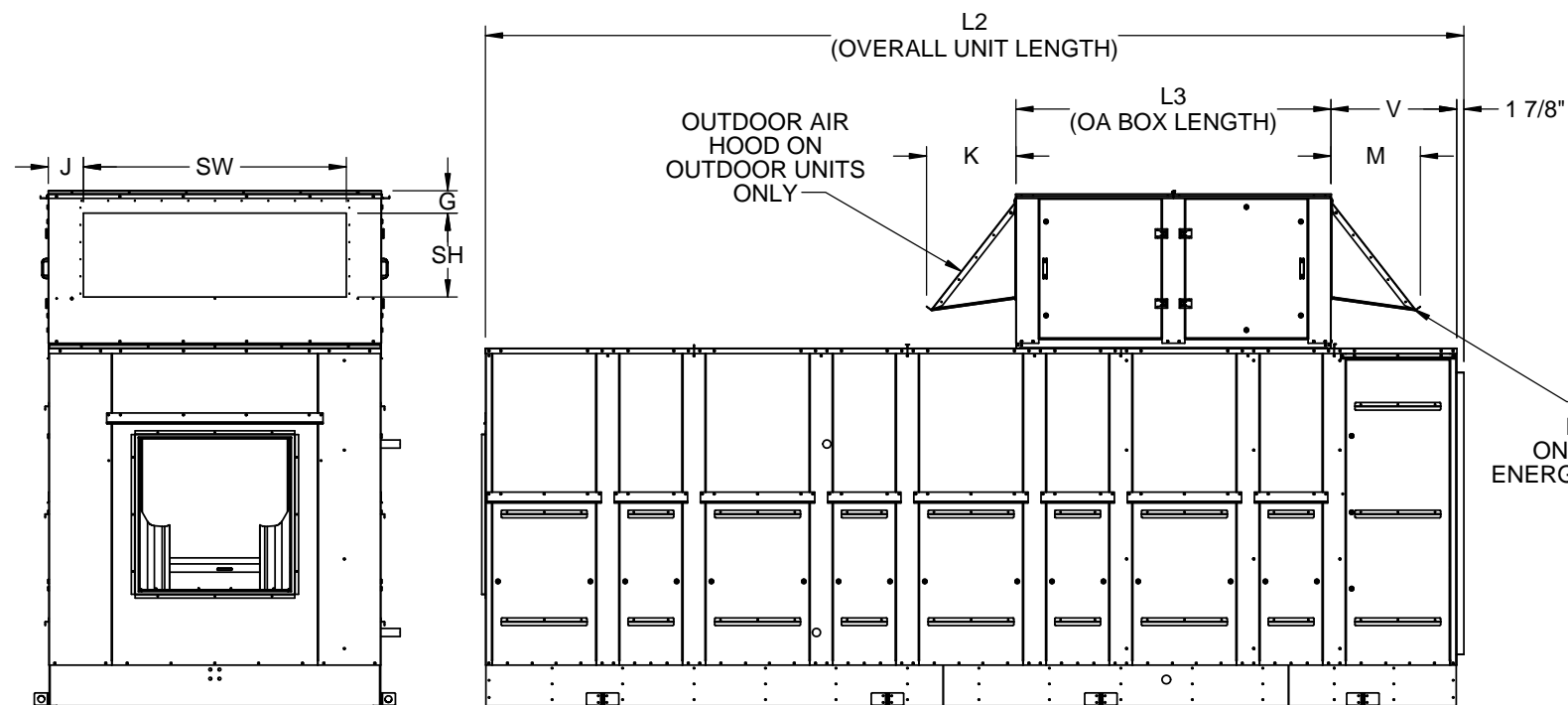
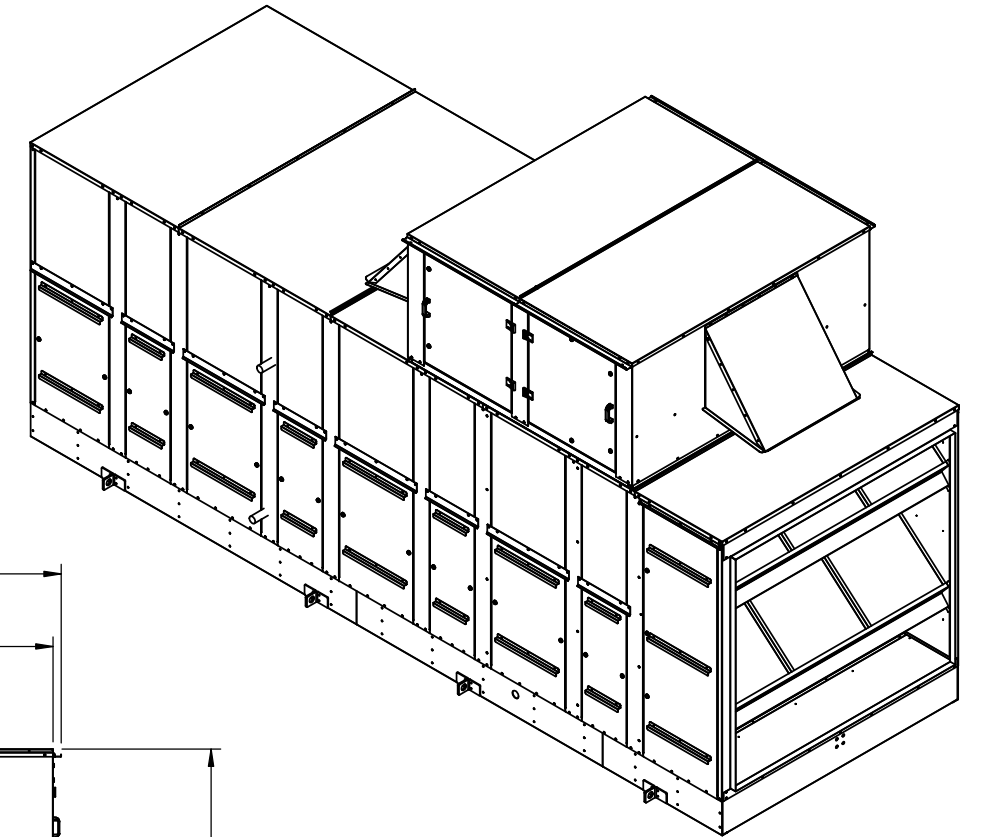
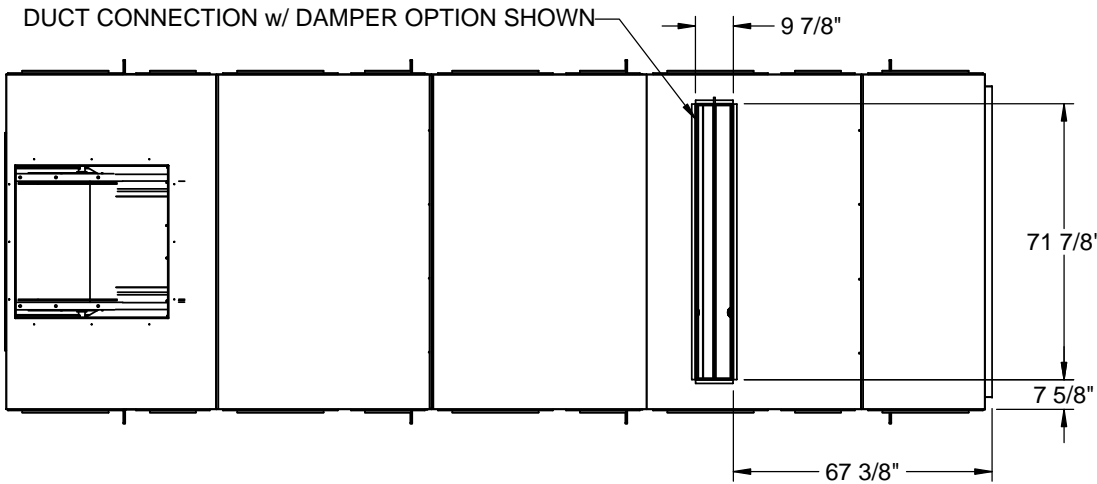

HOODS OMITTED FOR CLARITY

OA FILTERS	MODEL SIZE	PART NUMBER	QTY	NOM WIDTH	NOM HEIGHT	NOM DEPTH
DISPOSABLE	60	870-012	2	24	24	4
		870-041	2	20		

UNIT TYPE	MODEL SIZE	OA INTAKE OPENING				EXHAUST DISCHARGE OPENING			
		SH	SW	G	J	EH	EW	N	P
WITHOUT ENERGY RECOVERY	60	22 1/8	77 1/4	2 7/8	5	N/A	N/A	N/A	N/A
WITH ENERGY RECOVERY	60	19 1/2	66 1/2	7 1/8	10 3/8	20	30	4 1/4	28 5/8

Desert Aire has a policy of continuous product and quality improvement. Specifications and dimensions are subject to change without notice. This drawing and information contained herein are the exclusive property of the Desert Aire Corporation. Any use detrimental to the interests of Desert Aire is prohibited.

All Dimensions in Inches
All Angles 90°
All outside corners 0.125" fillet
Unless Otherwise Specified

Tolerance Unless Otherwise Specified
X.X ±.125
X.XX ±.060
X.XXX ±.030
Angles ±1°

DESERT AIRE
N120 W18485 FREISTADT RD
GERMANTOWN, WI 53022
Tel: (262) 946-7400
Fax: (262) 946-7401

Third Angle Projection

Part weight

Drawn	ASV	Date Released	12/5/2014	Description	SA60 STD RETURN W/AUX HEAT
Sheet	3/7			Page Title	OUTDOOR AIR/EXHAUST DETAILS
Scale	NTS		Rev.	0	Drawing Number
					G900-006

ALL DIMENSIONS ARE IN INCHES
FRACTIONAL TOLERANCE ± 1/8"

60 TON				
BLOWER	DH1	DW1	R1	Q1
ATLI 25-25	31 3/4	31 3/4	26 3/8	27 7/8
ATZAF 25-25	31 3/4	31 3/4	26 3/8	27 7/8
ATZAF 28-28	35 1/2	35 1/2	28 3/8	26
ATZAF 32-32	39 3/4	39 3/4	30 5/8	23 7/8

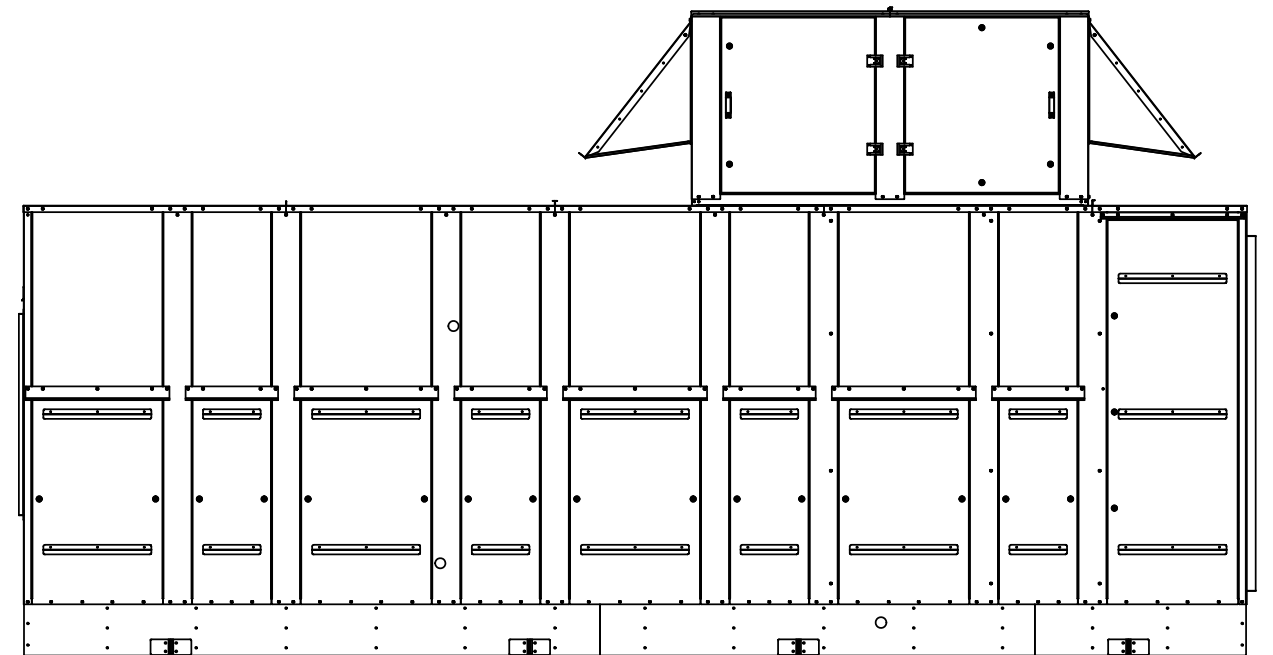
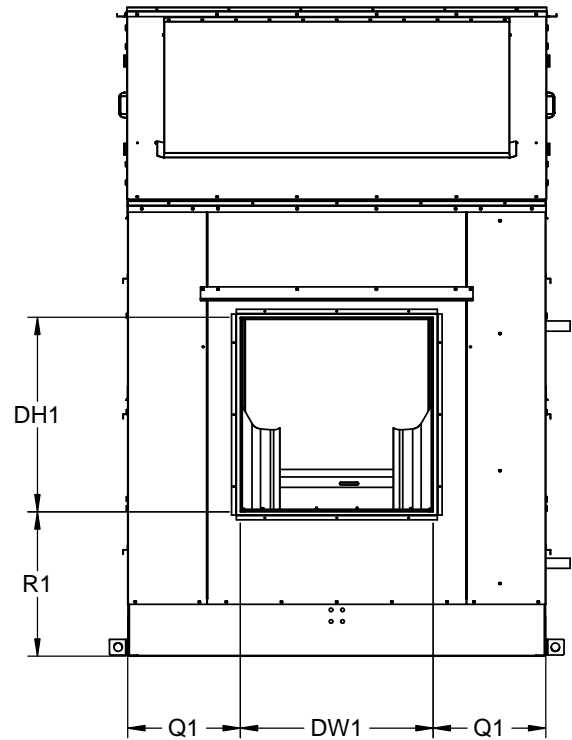
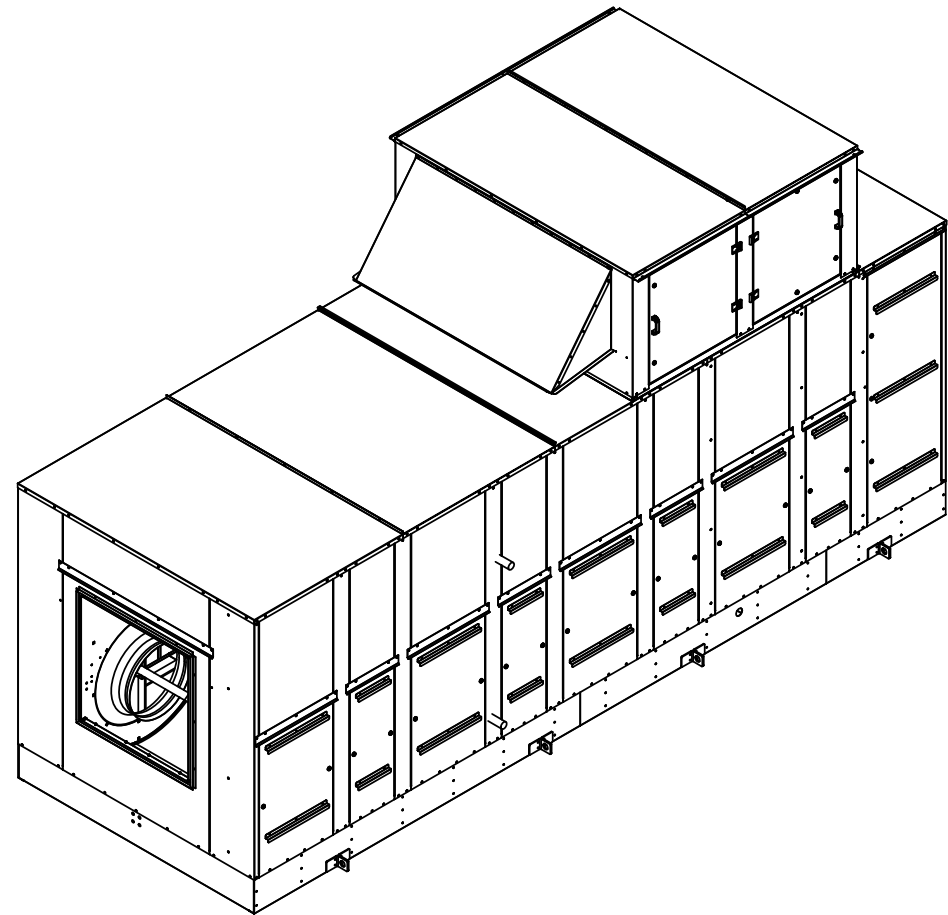

Desert Aire has a policy of continuous product and quality improvement. Specifications and dimensions are subject to change without notice. This drawing and information contained herein are the exclusive property of the Desert Aire Corporation. Any use detrimental to the interests of Desert Aire is prohibited.

ALL DIMENSIONS ARE IN INCHES
FRACTIONAL TOLERANCE ± 1/8"

All Dimensions in Inches
All Angles 90°
All outside corners 0.125" fillet
Unless Otherwise Specified

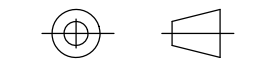

Third Angle Projection

Part weight

Tolerance Unless Otherwise Specified
X.X ±.125
X.XX ±.060
X.XXX ±.030
Angles ±1°



N120 W18485 FREISTADT RD
GERMANTOWN, WI 53022
Tel: (262) 946-7400
Fax: (262) 946-7401

Drawn ASV	Date Released 12/5/2014	Description SA60 STD RETURN W/AUX HEAT
---------------------	-----------------------------------	--

Sheet 4/7	Page Title END SUPPLY
---------------------	---------------------------------

Scale NTS	Rev. 0	Drawing Number G900-006
---------------------	------------------	-----------------------------------

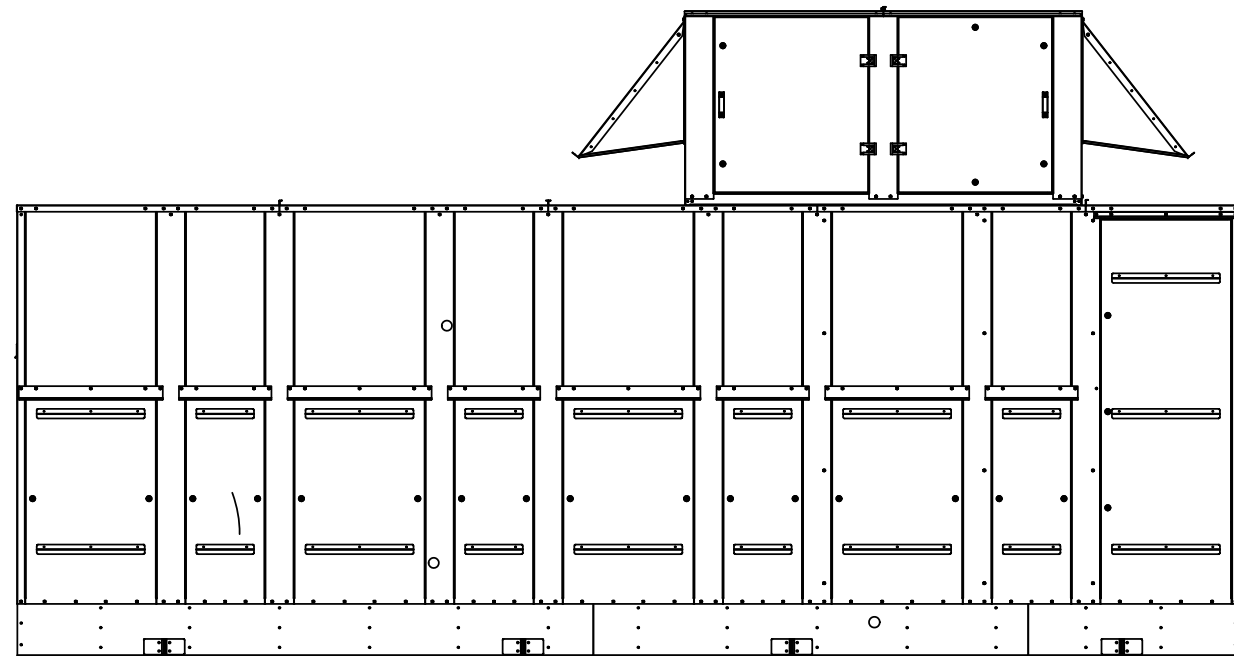
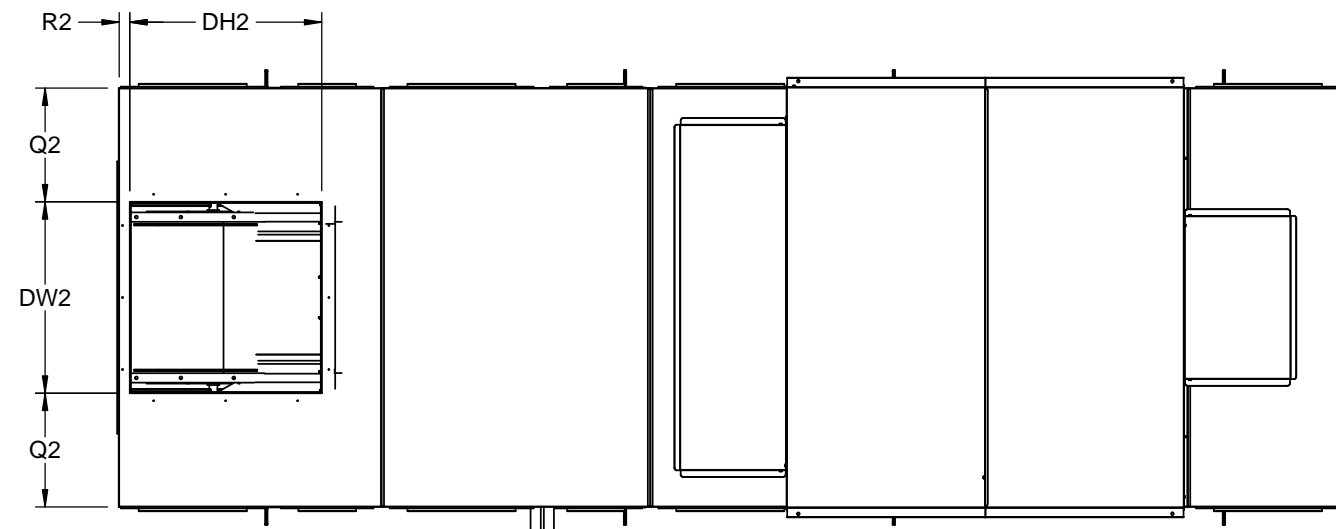

60 TON					
BLOWER	DH2	DW2	R2		Q2
			OVER	AWAY	
ATLI 25-25	31 3/4	31 3/4	1 3/8	14 7/8	27 7/8
ATZAF 25-25	31 3/4	31 3/4	1 3/8	14 7/8	27 7/8
ATZAF 28-28	35 1/2	35 1/2	1 3/8	16 7/8	26
ATZAF 32-32	39 3/4	39 3/4	1 3/8	19 1/8	23 7/8

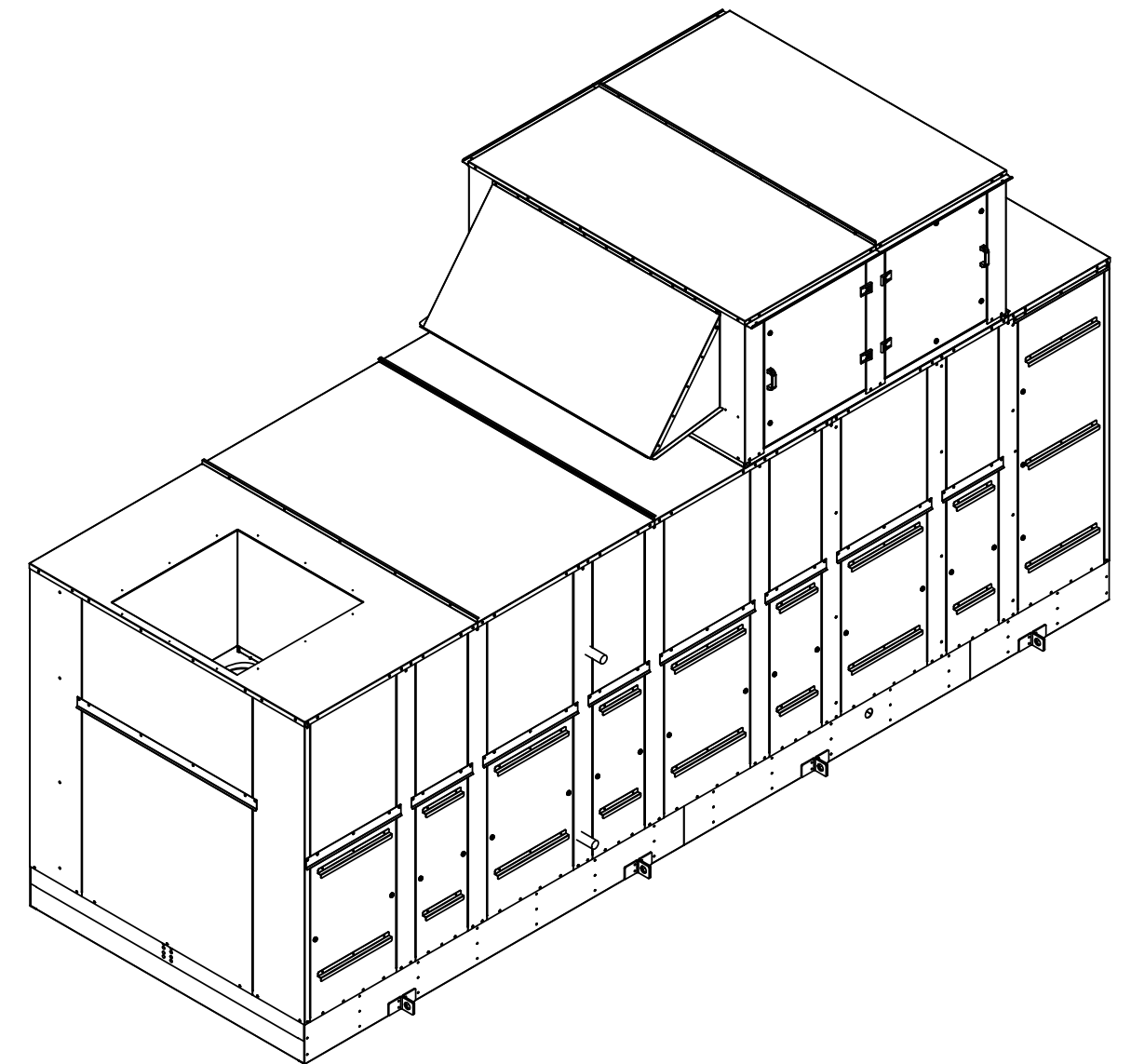

Desert Aire has a policy of continuous product and quality improvement. Specifications and dimensions are subject to change without notice. This drawing and information contained herein are the exclusive property of the Desert Aire Corporation. Any use detrimental to the interests of Desert Aire is prohibited.

All Dimensions in Inches
All Angles 90°
All outside corners 0.125" fillet
Unless Otherwise Specified

Tolerance Unless Otherwise Specified
X.X ±.125
X.XX ±.060
X.XXX ±.030
Angles ±1°

DESERT AIRE
N120 W18485 FREISTADT RD
GERMANTOWN, WI 53022
Tel: (262) 946-7400
Fax: (262) 946-7401

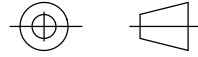
Third Angle Projection

Drawn ASV	Date Released 12/5/2014	Description SA60 STD RETURN W/AUX HEAT
---------------------	-----------------------------------	--

ALL DIMENSIONS ARE IN INCHES
FRACTIONAL TOLERANCE ± 1/8"

Part weight

Sheet 5/7	Page Title TOP SUPPLY
---------------------	---------------------------------

Scale NTS	Rev. 0	Drawing Number G900-006
---------------------	------------------	-----------------------------------

60 TON				
BLOWER	DH3	DW3	R3	Q3
ATLI 25-25	31 3/4	31 3/4	14 7/8	27 7/8
ATZAF 25-25	31 3/4	31 3/4	14 7/8	27 7/8
ATZAF 28-28	35 1/2	35 1/2	16 7/8	26
ATZAF 32-32	39 3/4	39 3/4	19 1/8	23 7/8

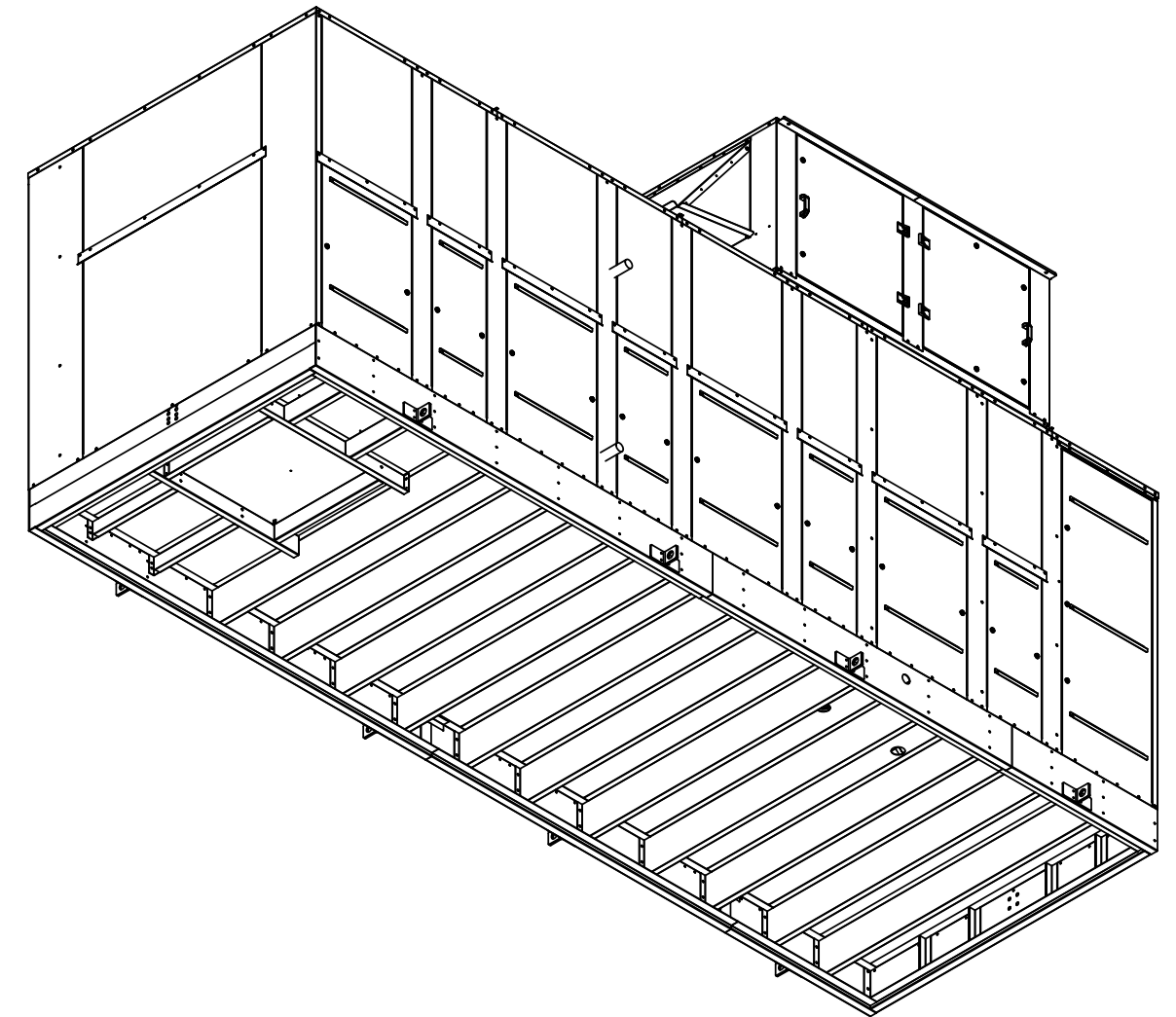
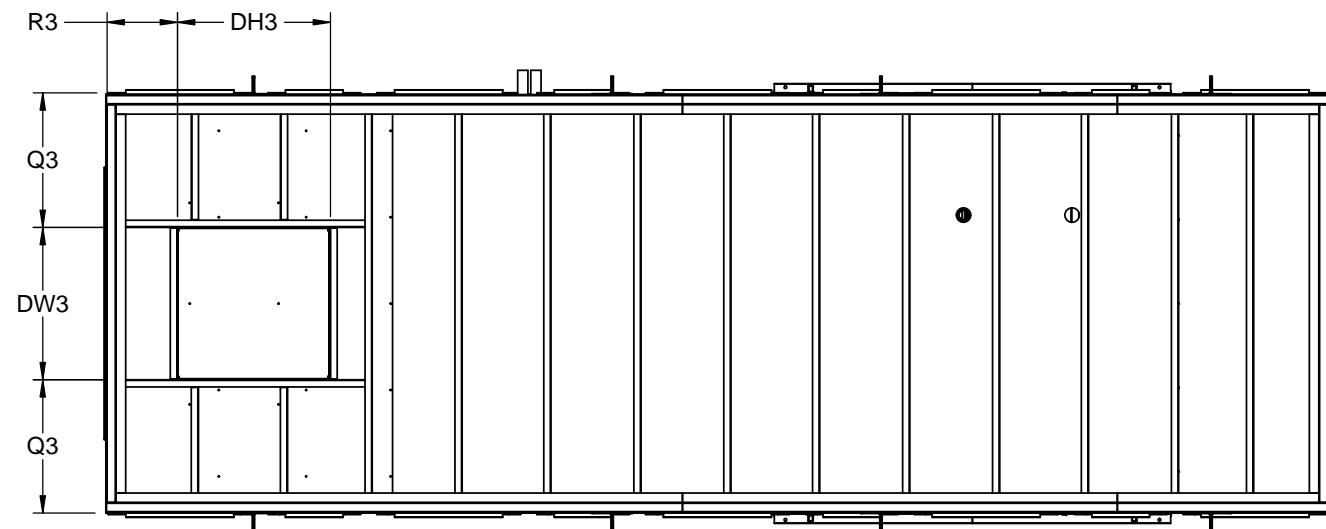
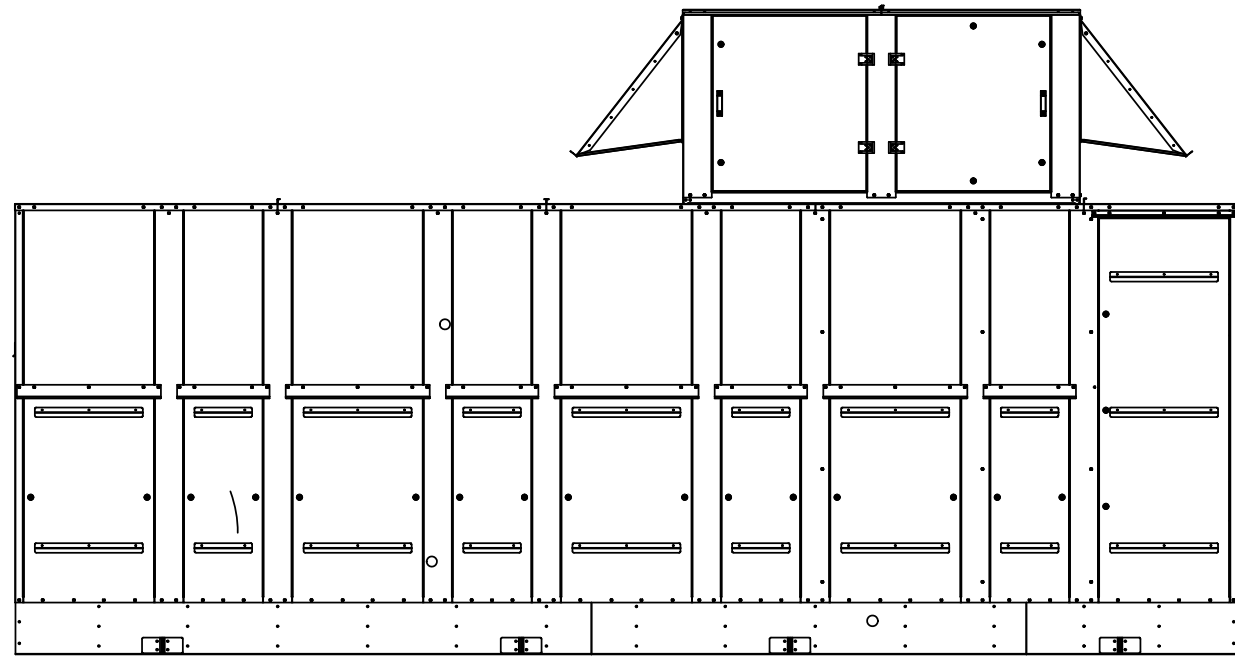

Desert Aire has a policy of continuous product and quality improvement. Specifications and dimensions are subject to change without notice. This drawing and information contained herein are the exclusive property of the Desert Aire Corporation. Any use detrimental to the interests of Desert Aire is prohibited.

ALL DIMENSIONS ARE IN INCHES
FRACTIONAL TOLERANCE $\pm 1/8"$

All Dimensions in Inches
All Angles 90°
All outside corners 0.125" fillet
Unless Otherwise Specified

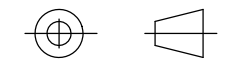

Third Angle Projection

Part weight

Tolerance Unless Otherwise Specified
X.X $\pm .125$
X.XX $\pm .060$
X.XXX $\pm .030$
Angles $\pm 1^\circ$



N120 W18485 FREISTADT RD
GERMANTOWN, WI 53022
Tel: (262) 946-7400
Fax: (262) 946-7401

Drawn ASV	Date Released 12/5/2014	Description SA60 STD RETURN W/AUX HEAT
---------------------	-----------------------------------	--

Sheet 6/7	Page Title DOWN SUPPLY
---------------------	----------------------------------

Scale NTS	Rev. 0	Drawing Number G900-006
---------------------	------------------	-----------------------------------

G900-006

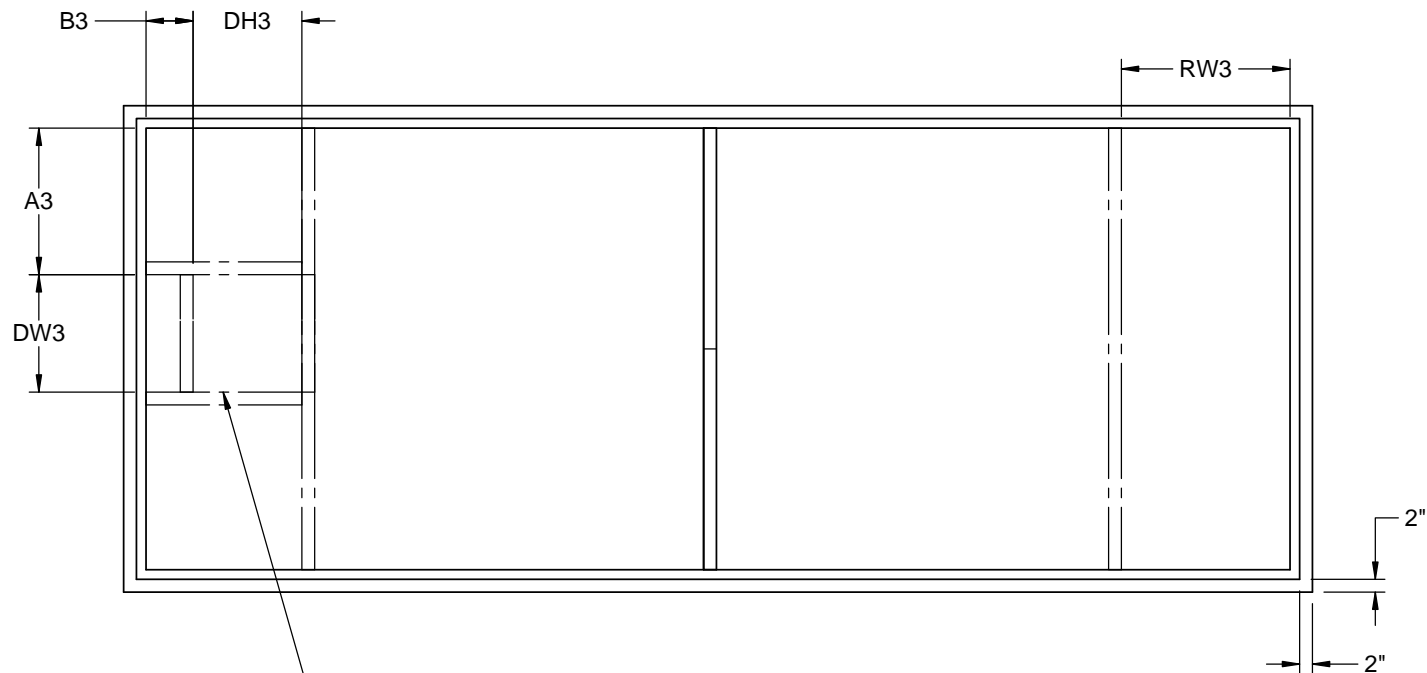

CONFIGURATION DEPENDANT
SUPPLY AIR
DUCT CONNECTION

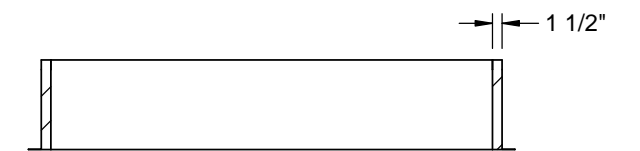
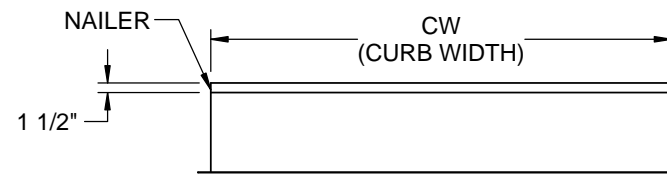
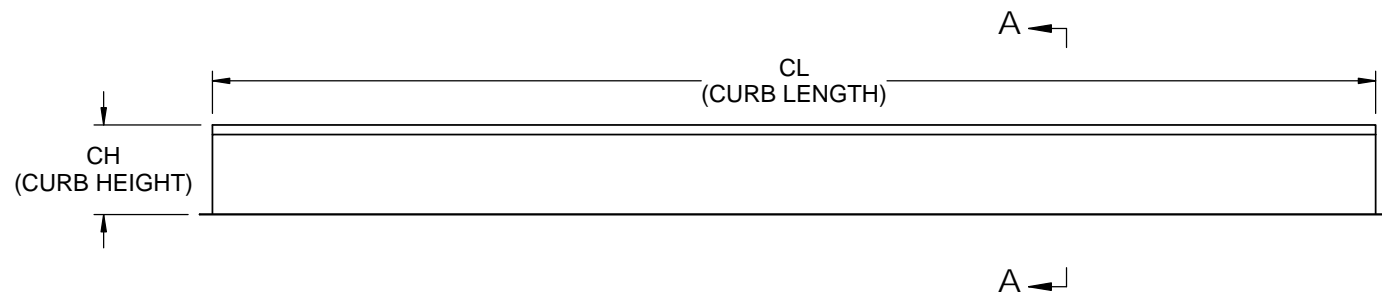

SECTION A-A

CURB PN	CURB		DOWN SUPPLY AND / OR DOWN RETURN				
	LENGTH	WIDTH	RW3	DW3	A3	DH3	B3
CB-LNDF-XX	249 5/8	82	124 7/8	31 3/4	23 5/8	31 3/4	10 7/8
CB-LNDK-XX	249 5/8	82	124 7/8	31 3/4	23 5/8	31 3/4	10 7/8
CB-LNDM-XX	249 5/8	82	124 7/8	35 1/2	21 3/4	35 1/2	12 7/8
CB-LNDN-XX	249 5/8	82	124 7/8	39 3/4	19 5/8	39 3/4	15 1/8
CB-LNDZ-XX	249 5/8	82	124 7/8	NO SUPPLY DUCT CONNECITON			

CURB HEIGHT IN INCHES DESIGNATED BY XX IN THE CURB PART NUMBER

----- DUCT CONNECTIONS FOR DOWN SUPPLY AND/OR DOWN RETURN

NOTES:
REFER TO SHEET 1 FOR GENERAL NOTES

CURBS 115" IN LENGTH AND LESS ARE SHIPPED AS COMPLETE CURBS, GREATER THAN 115" ARE SHIPPED KNOCKED DOWN.

NUMBER AND LOCATION OF CROSS SUPPORT(S) IS DEPENDANT UPON THE GAUGE OF MATERIAL USED TO CONSTRUCT THE CURB, DUCT SUPPORT CONFIGURATION, LENGTH OF CURB, AND WIDTH OF CURB. INSTALLATION INSTRUCTIONS INCLUDED WITH CURB SHIPMENT INDICATE THE REQUIRED POSITION FOR FIELD ASSEMBLED CURBS.

Desert Aire has a policy of continuous product and quality improvement. Specifications and dimensions are subject to change without notice. This drawing and information contained herein are the exclusive property of the Desert Aire Corporation. Any use detrimental to the interests of Desert Aire is prohibited.

All Dimensions in Inches
All Angles 90°
All outside corners 0.125" fillet
Unless Otherwise Specified

Tolerance Unless
Otherwise Specified
X.X ±.125
X.XX ±.060
X.XXX ±.030
Angles ±1°

**DESERT
AIRE**
N120 W18485 FREISTADT RD
GERMANTOWN, WI 53022
Tel: (262) 946-7400
Fax: (262) 946-7401

Third Angle Projection

Part weight

ALL DIMENSIONS ARE IN INCHES
TOLERANCE ± 1/8"

Drawn ASV	Date Released 12/5/2014	Description SA60 STD RETURN W/AUX HEAT
Sheet 7/7	Page Title CURB DETAILS	
Scale NTS	Rev. 0	Drawing Number G900-006