

G900-005

NON-VENTILATION UNIT SHOWN

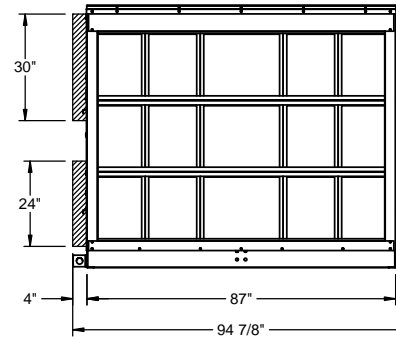
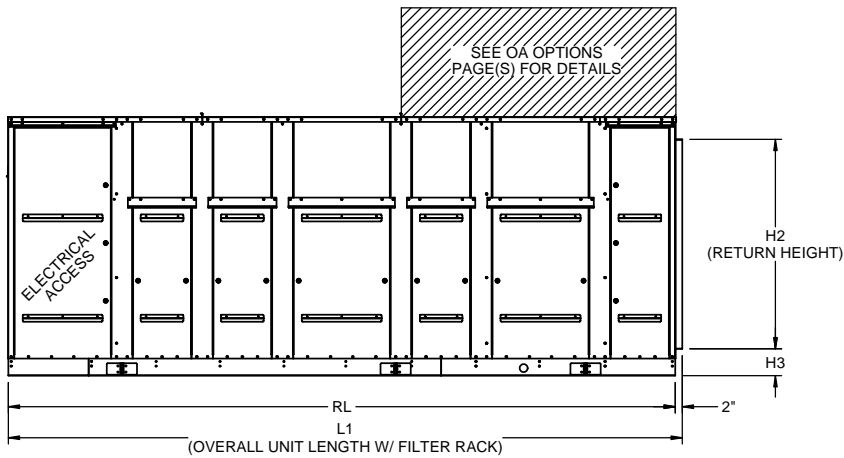
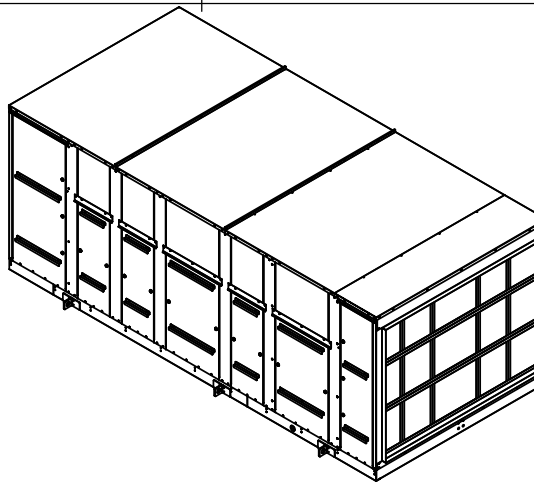
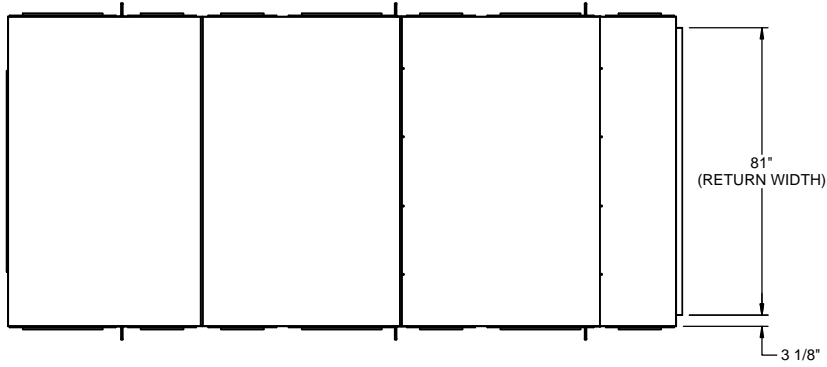

OPTIONAL OUTDOOR HOODS OMITTED FOR CLARITY
SEE OA BOX OPTION PAGES FOR DETAILED INFORMATION

UNIT TYPE	MODEL SIZE	RL	L1	UH	H2	H3
WITHOUT ENERGY RECOVERY	35	187 7/8	190	73 7/8	59	7 5/8
	40	187 7/8	190	73 7/8	59	7 5/8
	45	187 7/8	190	88 7/8	74	7 5/8
	50	187 7/8	190	88 7/8	74	7 5/8
WITH ENERGY RECOVERY	35	187 7/8	190	73 7/8	59	7 5/8
	40	187 7/8	190	73 7/8	59	7 5/8
	45	187 7/8	190	88 7/8	74	7 5/8
	50	187 7/8	190	88 7/8	74	7 5/8

FILTER OPTION	MODEL SIZE	PART NUMBER	QTY	NOM WIDTH	NOM HEIGHT	NOM DEPTH
DISPOSABLE	35	870-028	12	16	20	4
		870-041	3	24		
	40	870-028	12	16	20	4
		870-041	3	24		
		870-035	9	25		
DEACTIVATOR	35	870-035	9	25	29	4
		872-001	12	16	20	2
		870-022				
		872-006	3	24		
	870-043	3	24			
	40	872-001	12	16	20	2
		870-022				
		870-006	3	24		
	45	870-008	9	25	29	2
		870-073	9	25	29	2
50	872-008	9	25	29	2	
	872-073					

GENERAL NOTES FOR APPLICABLE SHEETS:

- VIEWS ARE FOR PICTORAL PURPOSES.
- REFER TO SUBMITTAL FOR CUSTOMER CONNECTION LOCATIONS.
- DIMENSIONS ARE TO ACCESS SIDE OF UNIT.
- LH ACCESS SHOWN FOR DISPLAY PURPOSES. ACCESS DOOR CONFIGURATION MAY CHANGE DEPENDING ON UNIT SIZE OR TYPE
- REFER TO SHEET 4,5,6 FOR INTAKE AND DISCHARGE CONNECTION DIMENSIONS.

Desert Aire has a policy of continuous product and quality improvement. Specifications and dimensions are subject to change without notice. This drawing and information contained herein are the exclusive property of the Desert Aire Corporation. Any use detrimental to the interests of Desert Aire is prohibited.	All Dimensions in Inches All Angles 90° All outside corners 0.125" fillet Unless Otherwise Specified	Tolerance Unless Otherwise Specified X.X ±.125 X.XX ±.060 X.XXX ±.030 Angles ±1°	N120 W18485 FREISTADT RD GERMANTOWN, WI 53022 Tel: (262) 946-7400 Fax: (262) 946-7401
ALL DIMENSIONS ARE IN INCHES FRACTIONAL TOLERANCE ± 1/8"		Third Angle Projection	Sheet 1/7 Page Title GENERAL INFORMATION
Part weight	Scale NTS	Rev. 1	Drawing Number G900-005

G900-005

ENERGY RECOVERY OPTION SHOWN

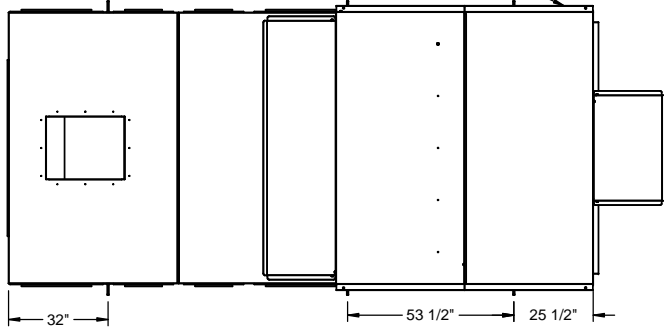

LIFTING LUG LOCATIONS

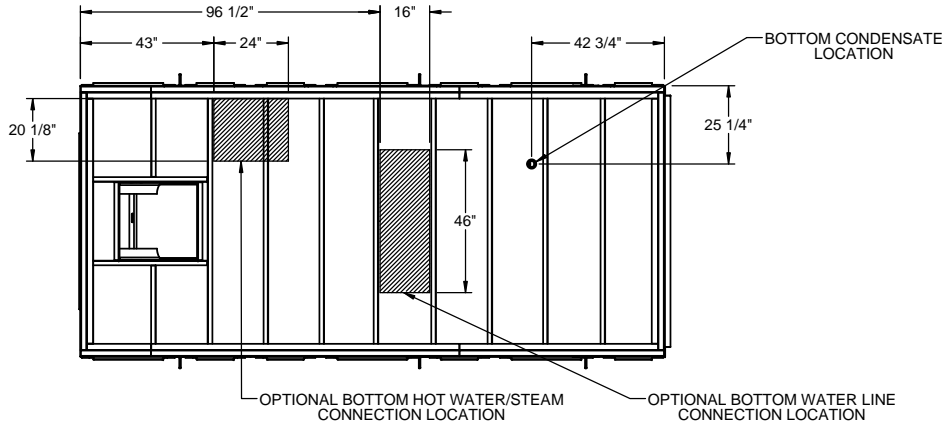
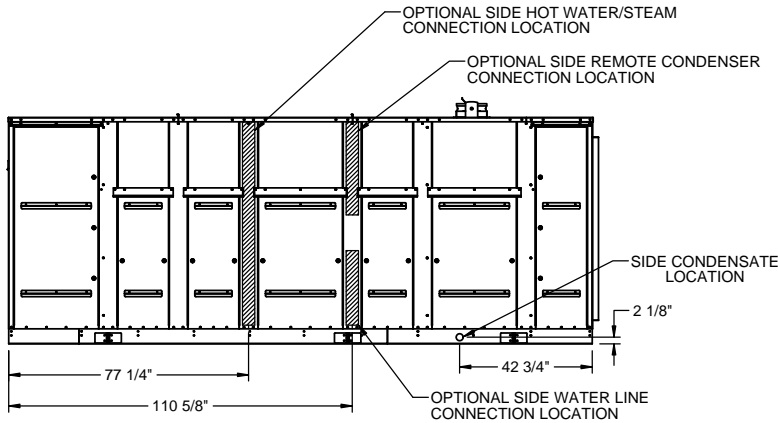

DUCT CONNECTION w/DAMPER OPTION SHOWN

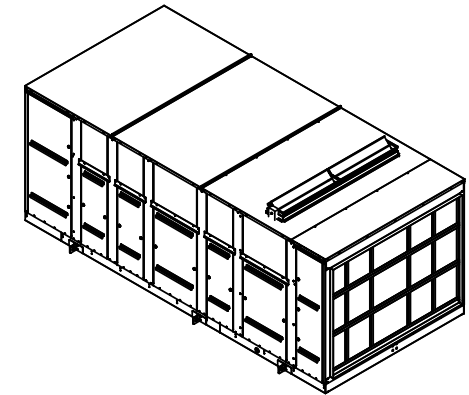
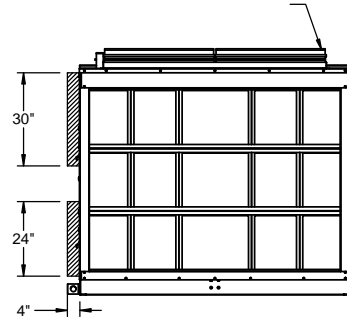

UNIT TYPE	MODEL SIZE	POOL WATER		CIRCUIT A		CIRCUIT B	
		CIRCUIT A	CIRCUIT B	DISCH DIA	LIQUID DIA	DISCH DIA	LIQUID DIA
WITHOUT ENERGY RECOVERY	35	1 1/2	2	1 1/8	3/4	1 3/8	3/4
	40	1 1/2	2	1 1/8	3/4	1 3/8	1 1/8
	45	2	2	1 3/8	7/8	1 3/8	7/8
	50	2	2	1 3/8	7/8	1 5/8	1 1/8
WITH ENERGY RECOVERY	35	1 1/2	2	1 1/8	3/4	1 3/8	3/4
	40	1 1/2	2	1 1/8	3/4	1 3/8	1 1/8
	45	2	2	1 3/8	7/8	1 3/8	7/8
	50	2	2	1 3/8	7/8	1 5/8	1 1/8

LEFT HAND CONNECTION OPTIONS SHOWN
RIGHT HAND CONNECTION OPTIONS LOCATED WITH SAME DIMENSIONS OPPOSITE SIDE WHEN SPECIFIED

Desert Aire has a policy of continuous product and quality improvement. Specifications and dimensions are subject to change without notice. This drawing and information contained herein are the exclusive property of the Desert Aire Corporation. Any use detrimental to the interests of Desert Aire is prohibited.	All Dimensions in Inches All Angles 90° All outside corners 0.125" fillet Unless Otherwise Specified	Tolerance Unless Otherwise Specified X.X ±.125 X.XX ±.060 X.XXX ±.030 Angles ±1°	N120 W18485 FREISTADT RD GERMANTOWN, WI 53022 Tel: (262) 946-7400 Fax: (262) 946-7401
ALL DIMENSIONS ARE IN INCHES FRACTIONAL TOLERANCE ± 1/8"		Third Angle Projection	Sheet 2/7 Page Title CUSTOMER CONNECTIONS
Part weight	Scale NTS	Rev. 1	Drawing Number G900-005

① HOODS NOT PROVIDED ON INDOOR UNITS.
NOTE: SOME OUTDOOR CONFIGURATIONS
WILL NOT OVERHANG CABINET.

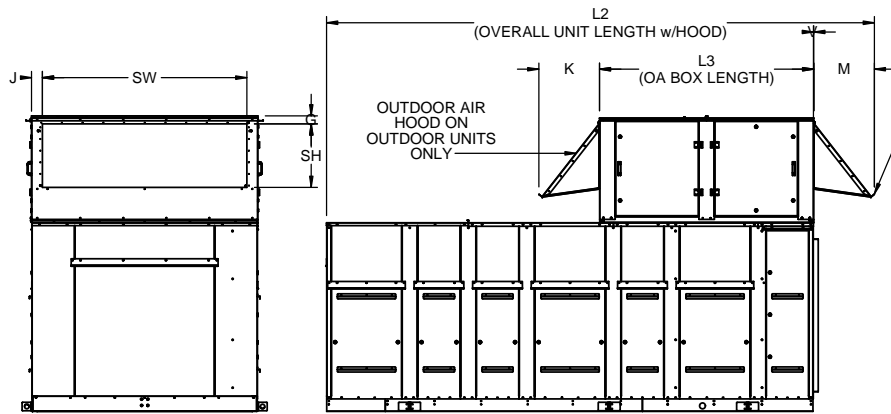
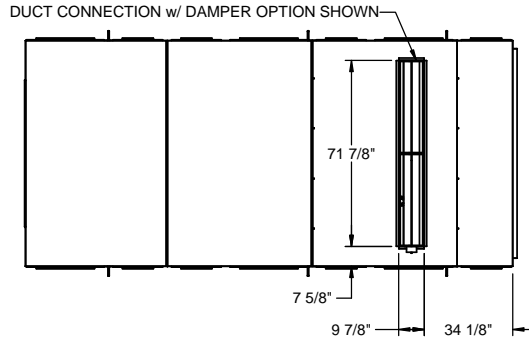

HOODS OMITTED FOR CLARITY

UNIT TYPE	MODEL SIZE	H1			L2 ①		V	OA BOX					
		NO VENTILATION	DUCT CONNECTION	OA BOX	INDOOR	OUTDOOR		HOOD(S)		L3	OUTDOOR OVERALL	W2	W1
								K	M				
WITHOUT ENERGY RECOVERY	35	73 7/8	77 1/4	102 1/4	190	190	23	18 7/8	N/A	44 1/2	63 3/8	87 1/8	91 3/8
	40	73 7/8	77 1/4	102 1/4	190	190	23	18 7/8	N/A	44 1/2	63 3/8	87 1/8	91 3/8
	45	88 7/8	92 1/4	117 1/4	190	190	23	18 7/8	N/A	44 1/2	63 3/8	87 1/8	91 3/8
WITH ENERGY RECOVERY	35	N/A	N/A	114 1/4	190	211 5/8	0	23 3/8	23 3/8	82 3/4	129 5/8	87 1/8	91 3/4
	40	N/A	N/A	114 1/4	190	211 5/8	0	23 3/8	23 3/8	82 3/4	129 5/8	87 1/8	91 3/4
	45	N/A	N/A	129 1/4	190	211 5/8	0	23 3/8	23 3/8	82 3/4	129 5/8	87 1/8	91 3/4
	50	N/A	N/A	129 1/4	190	211 5/8	0	23 3/8	23 3/8	82 3/4	129 5/8	87 1/8	91 3/4

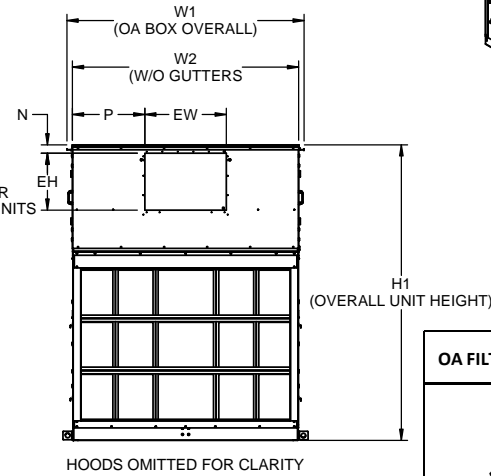
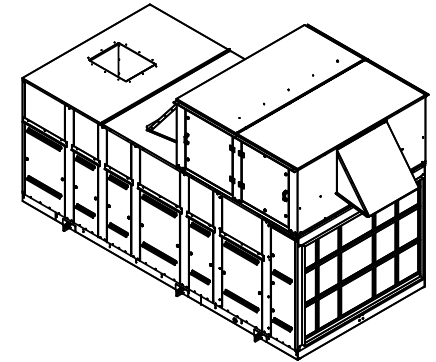

HOODS OMITTED FOR CLARITY

OA FILTERS	MODEL SIZE	PART NUMBER	QTY	NOM WIDTH	NOM HEIGHT	NOM DEPTH
DISPOSABLE	35	872-012	2	24	24	4
		870-041	2	20		
	40	872-012	2	24	24	4
		870-041	2	20		
	45	872-012	2	24	24	4
		870-041	2	20		
50	872-012	2	24	24	4	
	870-041	2	20			

UNIT TYPE	MODEL SIZE	OA INTAKE OPENING				EXHAUST DISCHARGE OPENING			
		SH	SW	G	J	EH	EW	N	P
WITHOUT ENERGY RECOVERY	35	22 1/8	77 1/4	2 7/8	5	N/A	N/A	N/A	N/A
	40	22 1/8	77 1/4	2 7/8	5	N/A	N/A	N/A	N/A
	45	22 1/8	77 1/4	2 7/8	5	N/A	N/A	N/A	N/A
	50	22 1/8	77 1/4	2 7/8	5	N/A	N/A	N/A	N/A
WITH ENERGY RECOVERY	35	19 1/2	66 1/2	7 1/8	10 3/8	20	30	4 1/4	28 5/8
	40	19 1/2	66 1/2	7 1/8	10 3/8	20	30	4 1/4	28 5/8
	45	19 1/2	66 1/2	7 1/8	10 3/8	20	30	4 1/4	28 5/8
	50	19 1/2	66 1/2	7 1/8	10 3/8	20	30	4 1/4	28 5/8

Desert Aire has a policy of continuous product and quality improvement. Specifications and dimensions are subject to change without notice. This drawing and information contained herein are the exclusive property of the Desert Aire Corporation. Any use detrimental to the interests of Desert Aire is prohibited.

All Dimensions in Inches
All Angles 90°
All outside corners 0.125" fillet
Unless Otherwise Specified

Tolerance Unless Otherwise Specified
X.X ±.125
X.XX ±.060
X.XXX ±.030
Angles ±1°

Drawn ASV Date Released 12/5/2014 Description SA35-50 STD RETURN w/AUX HEAT

Third Angle Projection

Sheet 3/7 Page Title OUTDOOR AIR/EXHAUST DETAILS

Scale NTS Rev 1 Drawing Number G900-005

G900-005

35 TON					40 TON					45 TON					50 TON				
BLOWER	DH1	DW1	R1	Q1	BLOWER	DH1	DW1	R1	Q1	BLOWER	DH1	DW1	R1	Q1	BLOWER	DH1	DW1	R1	Q1
ATLI 18-18	18 7/8	22 1/8	17 3/8	32 5/8	ATLI 18-18	18 7/8	22 1/8	17 3/8	32 5/8	ATLI 18-18	18 7/8	22 1/8	17 3/8	32 5/8	ATLI 22-22	28 1/4	28 1/4	18 7/8	29 5/8
ATLI 20-15	25 1/4	20 1/4	17 3/8	33 5/8	ATLI 20-15	25 1/4	20 1/4	17 3/8	33 5/8	ATLI 20-15	25 1/4	20 1/4	17 3/8	33 5/8	ATLI 25-25	31 3/4	31 3/4	20 3/8	27 7/8
ATZAF 22-22	28 1/4	28 1/4	18 7/8	29 5/8	ATZAF 22-22	28 1/4	28 1/4	18 7/8	29 5/8	ATZAF 25-25	31 3/4	31 3/4	20 3/8	27 7/8	ATZAF 25-25	31 3/4	31 3/4	20 3/8	27 7/8
ATZAF 25-25	31 3/4	31 3/4	20 3/8	27 7/8	ATZAF 25-25	31 3/4	31 3/4	20 3/8	27 7/8	ATZAF 28-28	35 1/2	35 1/2	22 3/8	26	ATZAF 28-28	35 1/2	35 1/2	22 3/8	26
ATZAF 28-28	35 1/2	35 1/2	22 3/8	26	ATZAF 28-28	35 1/2	35 1/2	22 3/8	26										

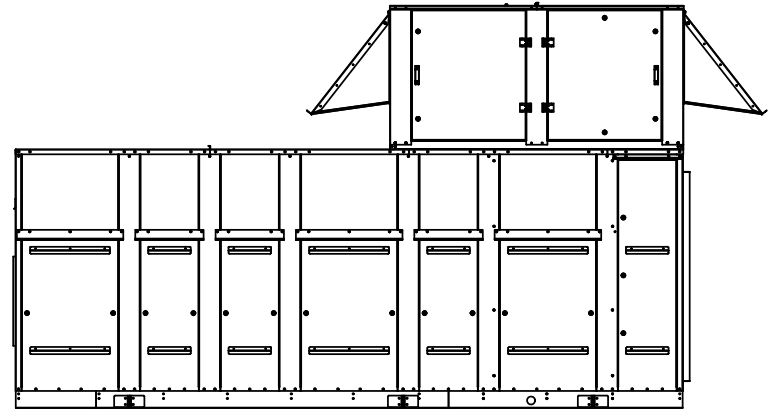
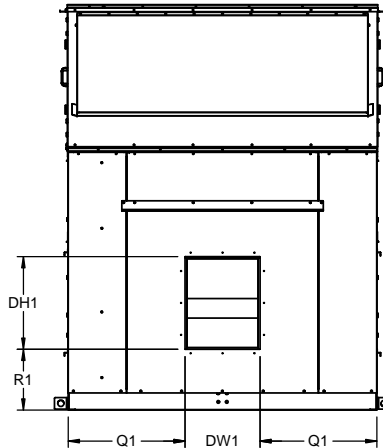
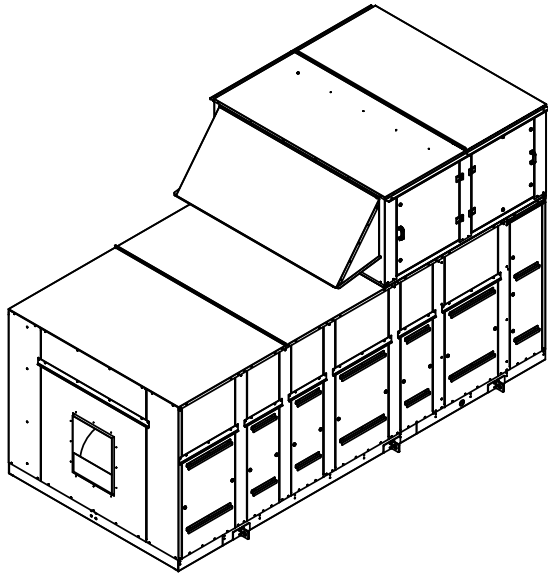

<p>Desert Aire has a policy of continuous product and quality improvement. Specifications and dimensions are subject to change without notice. This drawing and information contained herein are the exclusive property of the Desert Aire Corporation. Any use detrimental to the interests of Desert Aire is prohibited.</p> <p>ALL DIMENSIONS ARE IN INCHES FRACTIONAL TOLERANCE ± 1/8"</p>	<p>All Dimensions in Inches All Angles 90° All outside corners 0.125" fillet Unless Otherwise Specified</p> <p>Third Angle Projection</p>	<p>Tolerance Unless Otherwise Specified X.X ±.125 X.XX ±.060 X.XXX ±.030 Angles ±1°</p>	<p>N120 W18485 FREISTADT RD GERMANTOWN, WI 53022 Tel: (262) 946-7400 Fax: (262) 946-7401</p>
		<p>Sheet 4/7</p>	<p>Page Title END SUPPLY</p>
		<p>Scale NTS</p>	<p>Rev. 1 Drawing Number G900-005</p>

G900-005

BLOWER	35 TON					40 TON					45 TON					50 TON							
	DH2	DW2	R2		Q2	BLOWER	DH2	DW2	R2		Q2	BLOWER	DH2	DW2	R2		Q2	BLOWER	DH2	DW2	R2		Q2
			OVER	AWAY					OVER	AWAY					OVER	AWAY					OVER	AWAY	
ATLI 18-18	18 7/8	22 1/8	2 1/8	11 7/8	32 5/8	ATLI 18-18	18 7/8	22 1/8	2 1/8	11 7/8	32 5/8	ATLI 18-18	18 7/8	22 1/8	2 1/8	11 7/8	32 5/8	ATLI 22-22	28 1/4	28 1/4	2 1/8	13 3/8	29 5/8
ATLI 20-15	25 1/4	20 1/4	2 1/8	11 7/8	33 5/8	ATLI 20-15	25 1/4	20 1/4	2 1/8	11 7/8	33 5/8	ATLI 20-15	25 1/4	20 1/4	2 1/8	11 7/8	33 5/8	ATLI 25-25	31 3/4	31 3/4	2 1/8	14 7/8	27 7/8
ATZAF 22-22	28 1/4	28 1/4	2 1/8	13 3/8	29 5/8	ATZAF 22-22	28 1/4	28 1/4	2 1/8	13 3/8	29 5/8	ATZAF 25-25	31 3/4	31 3/4	2 1/8	14 7/8	27 7/8	ATZAF 25-25	31 3/4	31 3/4	2 1/8	14 7/8	27 7/8
ATZAF 25-25	31 3/4	31 3/4	2 1/8	14 7/8	27 7/8	ATZAF 25-25	31 3/4	31 3/4	2 1/8	14 7/8	27 7/8	ATZAF 28-28	35 1/2	35 1/2	2 1/8	16 7/8	26	ATZAF 28-28	35 1/2	35 1/2	2 1/8	16 7/8	26
ATZAF 28-28	35 1/2	35 1/2	2 1/8	16 7/8	26	ATZAF 28-28	35 1/2	35 1/2	2 1/8	16 7/8	26												

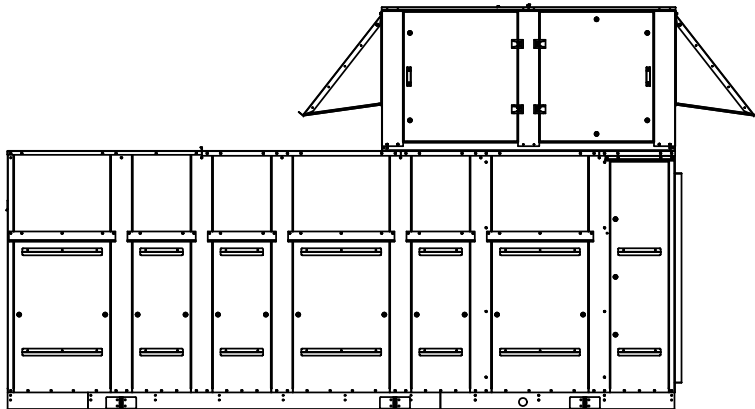
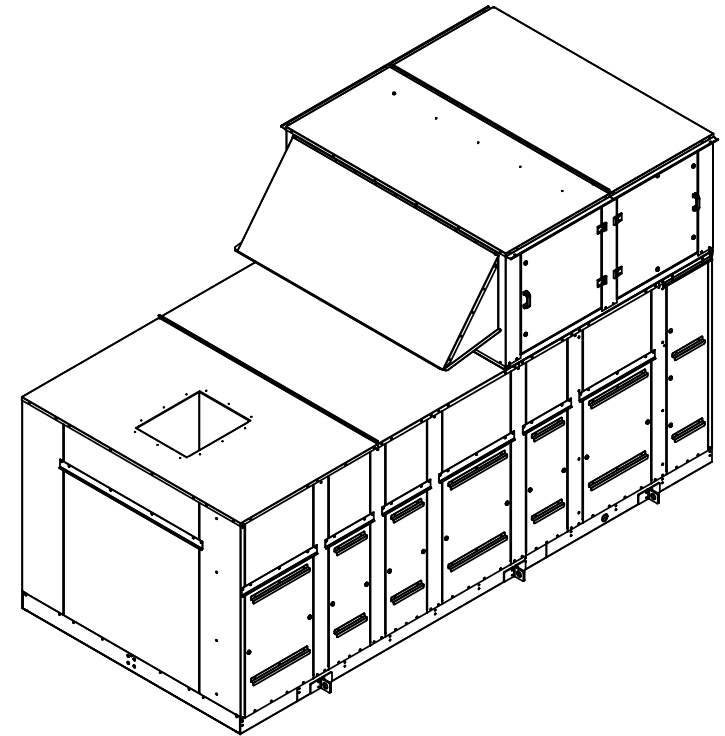
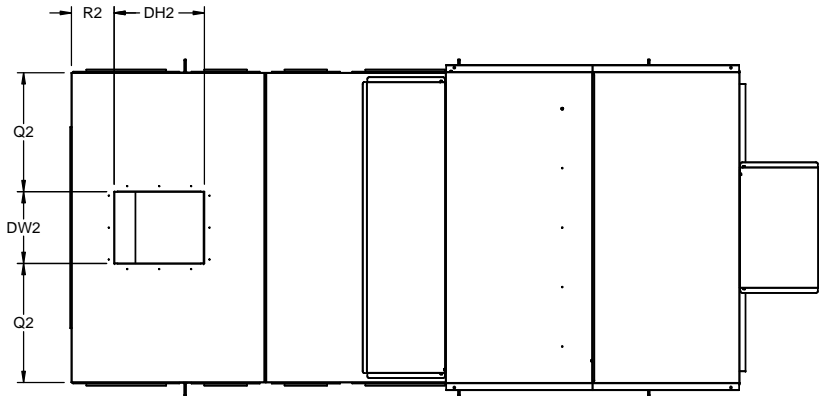

<p>Desert Aire has a policy of continuous product and quality improvement. Specifications and dimensions are subject to change without notice. This drawing and information contained herein are the exclusive property of the Desert Aire Corporation. Any use detrimental to the interests of Desert Aire is prohibited.</p>	<p>All Dimensions in Inches All Angles 90° All outside corners 0.125" fillet Unless Otherwise Specified</p>	<p>Tolerance Unless Otherwise Specified X.X ±.125 X.XX ±.060 X.XXX ±.030 Angles ±1°</p>	 <p>N120 W18485 FREISTADT RD GERMANTOWN, WI 53022 Tel: (262) 946-7400 Fax: (262) 946-7401</p>
<p>Third Angle Projection</p>		<p>Sheet 5/7</p>	<p>Page Title TOP SUPPLY</p>
<p>Part weight</p>	<p>Scale NTS</p>	<p>Rev. 1</p>	<p>Drawing Number G900-005</p>

35 TON					40 TON					45 TON					50 TON				
BLOWER	DH3	DW3	R3	Q3	BLOWER	DH3	DW3	R3	Q3	BLOWER	DH3	DW3	R3	Q3	BLOWER	DH3	DW3	R3	Q3
ATLI 18-18	18 7/8	22 1/8	11 7/8	32 5/8	ATLI 18-18	18 7/8	22 1/8	11 7/8	32 5/8	ATLI 18-18	18 7/8	22 1/8	11 7/8	32 5/8	ATLI 22-22	28 1/4	28 1/4	13 3/8	29 5/8
ATLI 20-15	25 1/4	20 1/4	11 7/8	33 5/8	ATLI 20-15	25 1/4	20 1/4	11 7/8	33 5/8	ATLI 20-15	25 1/4	20 1/4	11 7/8	33 5/8	ATLI 25-25	31 3/4	31 3/4	14 7/8	27 7/8
ATZAF 22-22	28 1/4	28 1/4	13 3/8	29 5/8	ATZAF 22-22	28 1/4	28 1/4	13 3/8	29 5/8	ATZAF 25-25	31 3/4	31 3/4	14 7/8	27 7/8	ATZAF 25-25	31 3/4	31 3/4	14 7/8	27 7/8
ATZAF 25-25	31 3/4	31 3/4	14 7/8	27 7/8	ATZAF 25-25	31 3/4	31 3/4	14 7/8	27 7/8	ATZAF 28-28	35 1/2	35 1/2	16 7/8	26	ATZAF 28-28	35 1/2	35 1/2	16 7/8	26
ATZAF 28-28	35 1/2	35 1/2	16 7/8	26	ATZAF 28-28	35 1/2	35 1/2	16 7/8	26										

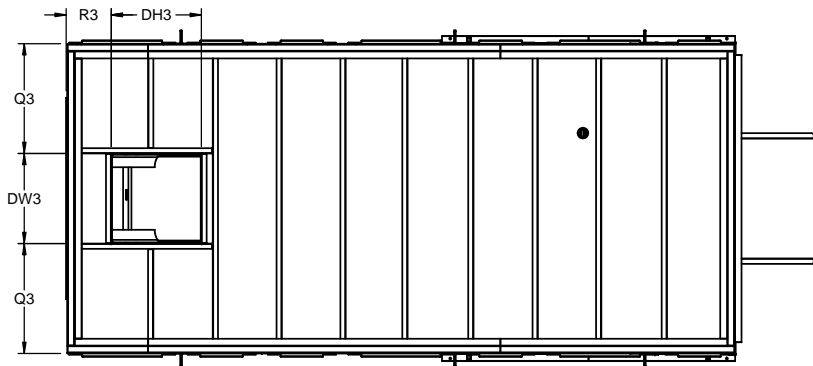
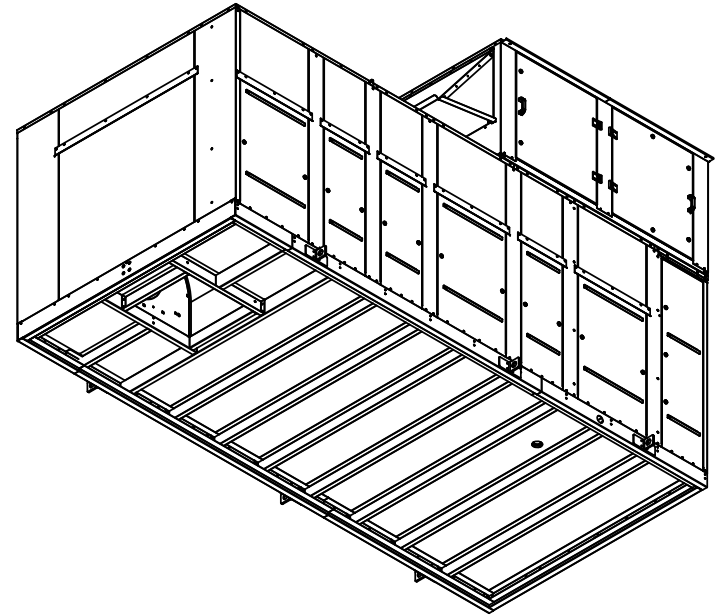
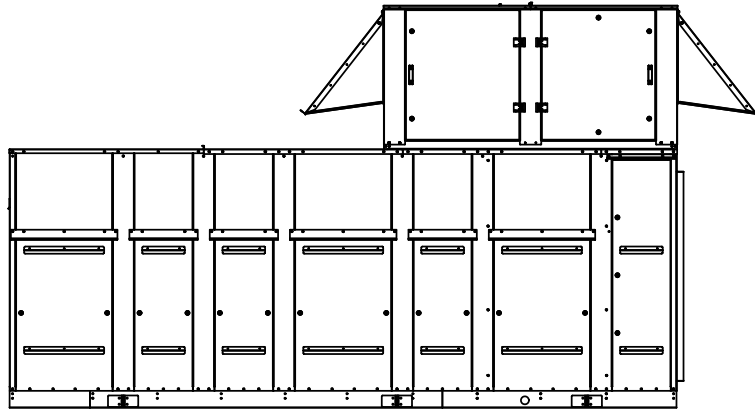

Desert Aire has a policy of continuous product and quality improvement. Specifications and dimensions are subject to change without notice. This drawing and information contained herein are the exclusive property of the Desert Aire Corporation. Any use detrimental to the interests of Desert Aire is prohibited.	All Dimensions in Inches All Angles 90° All outside corners 0.125" fillet Unless Otherwise Specified	Tolerance Unless Otherwise Specified X.X ±.125 X.XX ±.060 X.XXX ±.030 Angles ±1°	N120 W18485 FREISTADT RD GERMANTOWN, WI 53022 Tel: (262) 946-7400 Fax: (262) 946-7401
ALL DIMENSIONS ARE IN INCHES FRACTIONAL TOLERANCE ± 1/8"		Third Angle Projection	Sheet: 6/7 Page Title: DOWN SUPPLY
Part weight	Scale: NTS	Rev: 1	Drawing Number: G900-005

G900-005

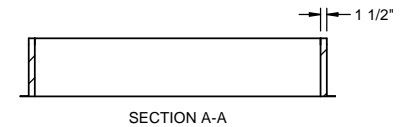
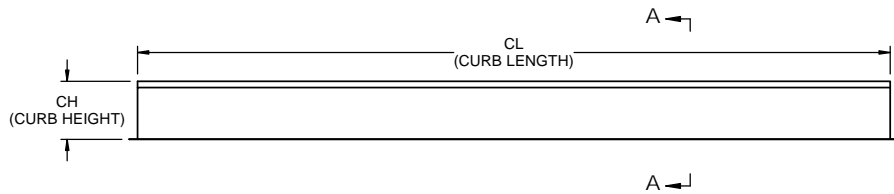
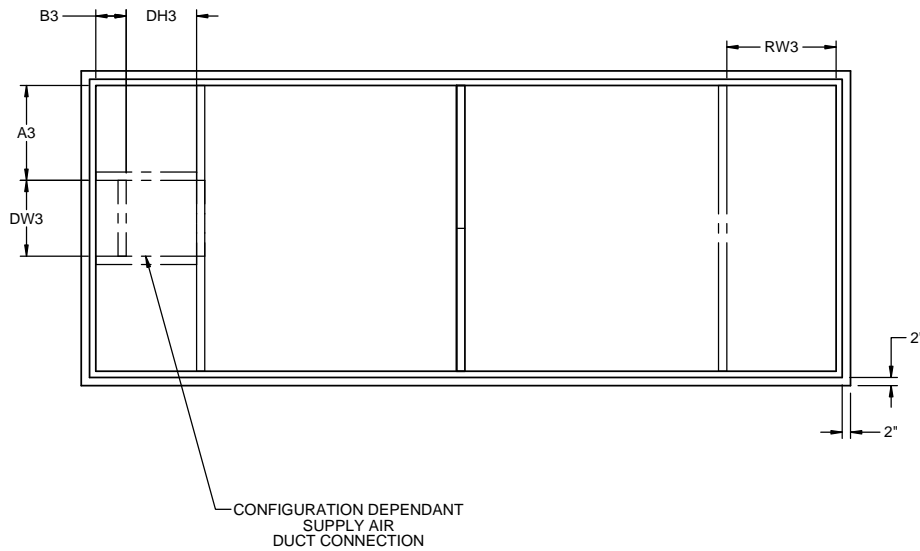

--- DUCT CONNECTIONS FOR DOWN SUPPLY AND/OR DOWN RETURN

NOTES:
REFER TO SHEET 1 FOR GENERAL NOTES

CURBS 115" IN LENGTH AND LESS ARE SHIPPED AS COMPLETE CURBS, GREATER THAN 115" ARE SHIPPED KNOCKED DOWN.

NUMBER AND LOCATION OF CROSS SUPPORT(S) IS DEPENDANT UPON THE GAUGE OF MATERIAL USED TO CONSTRUCT THE CURB, DUCT SUPPORT CONFIGURATION, LENGTH OF CURB, AND WIDTH OF CURB. INSTALLATION INSTRUCTIONS INCLUDED WITH CURB SHIPMENT INDICATE THE REQUIRED POSITION FOR FIELD ASSEMBLED CURBS.

CURB PN	CURB		DOWN SUPPLY AND / OR DOWN RETURN				
	LENGTH	WIDTH	RW3	DW3	A3	DH3	B3
CB-MNFC-XX	182 7/8	82	91 1/2	22 1/8	28 1/2	18 7/8	7 7/8
CB-MNFD-XX	182 7/8	82	91 1/2	20 1/4	29 3/8	25 1/4	7 1/8
CB-MNFE-XX	182 7/8	82	91 1/2	28 1/4	25 3/8	28 1/4	8 5/8
CB-MNFF-XX	182 7/8	82	91 1/2	31 3/4	23 5/8	31 3/4	10 1/8
CB-MNFJ-XX	182 7/8	82	91 1/2	28 1/4	25 3/8	28 1/4	8 5/8
CB-MNFK-XX	182 7/8	82	91 1/2	31 3/4	23 5/8	31 3/4	10 1/8
CB-MNFM-XX	182 7/8	82	91 1/2	35 1/2	21 3/4	35 1/2	12 1/8
CB-MNFZ-XX	182 7/8	82	91 1/2	NO SUPPLY/RETURN DUCT CONNECITON			

CURB HEIGHT IN INCHES DESIGNATED BY XX IN THE CURB PART NUMBER

Desert Aire has a policy of continuous product and quality improvement. Specifications and dimensions are subject to change without notice. This drawing and information contained herein are the exclusive property of the Desert Aire Corporation. Any use detrimental to the interests of Desert Aire is prohibited.	All Dimensions in Inches All Angles 90° All outside corners 0.125" fillet Unless Otherwise Specified	Tolerance Unless Otherwise Specified X.X ±.125 X.XX ±.060 X.XXX ±.030 Angles ±1°	N120 W18485 FREISTADT RD GERMANTOWN, WI 53022 Tel: (262) 946-7400 Fax: (262) 946-7401
ALL DIMENSIONS ARE IN INCHES TOLERANCE ± 1/8"	Third Angle Projection	Sheet 7/7 Page Title CURB DETAILS	Part weight Scale NTS Rev. 1 Drawing Number G900-005