

100% Outdoor Air Dehumidification Methods

INTRODUCTION

As consulting engineers and end users implement the ASHRAE 62 ventilation code, they are faced with selecting an appropriate method for dealing with moisture. This bulletin will describe the basic options available when moisture must be removed from the outside air before that air is introduced to the space. Since all of the moisture removal methods described involve significant cooling of the air, this bulletin will go on to explain and compare the reheat approaches that are available for each moisture removal method.

MODERN AIR HANDLERS AND ASHRAE 62

Modern air handlers that are used to control sensible and latent heat in interior spaces have moved to high efficiency designs in order to maximize the Energy Efficiency Ratio (EER) requirements of building codes. These high efficiency models shift handler capacity toward the sensible side (high sensible ratio) at the expense of moisture removing capacity. (See *Technical Bulletin 14 - ASHRAE Compliance Using Modern Air Handlers* for a detailed discussion.)

Meanwhile, increased application of ASHRAE 62 ventilation code has led to requirements that air handlers in new or existing construction accept up to 30% or more outdoor air. Since modern air handlers do not have the capacity to handle the resulting higher latent load, new problems arise in the form of mold, mildew, and high space humidity.

In existing buildings, air handlers are often programmed to run for longer periods of time in order to eliminate excess humidity. In new buildings, if the issue of moisture is recognized, the first impulse may be to simply add more air conditioning capacity. Either way, auxiliary heating (such as electric or gas heat) must be used because the air conditioning drives the temperature far too low for comfort. This approach results in a very high cost of operation.

MOISTURE REMOVAL METHODS

The situation just described has led to the use of various methods for pretreatment of outside air before it gets to the air handler or the space. These can be lumped into two broad categories. One group uses an *air conditioning unit* for pretreatment, but attempts to enhance the moisture-removal capacity of the unit by lowering the temperature of the outdoor air before it hits the air conditioner's evaporator. In this group are the air-to-air plate heat exchangers and the heat pipes described below.

The other group uses *refrigerant-based dehumidification* to remove moisture. Figure 1 shows an example of this type of dehumidifier being used to pre-treat 100% outdoor air for moisture removal before it's sent to the building or air handler.

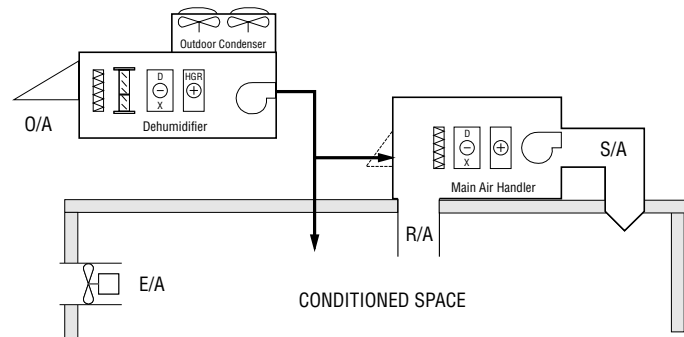

Figure 1) Typical Overall System Schematic. Air is pretreated by a dehumidifier, and sent to the air handler.

The common element when using either a dehumidifier or an air conditioner as a pretreatment unit is that moisture removal is based on a refrigeration coil, a compressor, and fans that draw the warm, moist air over a cold coil. For either approach, the option is available to introduce outdoor air directly into the space. In that instance, the pretreatment unit will likely require auxiliary heat for winter use to avoid discomfort.

REHEAT METHODS

All of these approaches have to deal with an important energy-related issue. Since they all *cool* the air significantly, they also need to *reheat* the air to keep it within an acceptable temperature range and to minimize the need for auxiliary heating. The method of reheat used divides the moisture removal approaches in a different way. One group, including the plate heat exchangers, heat pipes, and most dehumidifiers, uses *fixed reheat* techniques. That is to say that the amount of heat added back is always the same, because the reheat system is fixed in a particular mechanical configuration and cannot be controlled by the system to adjust the amount of reheat.

The other group, when dividing by reheat technique used, is comprised of the remainder of the dehumidifiers. These use some form of *variable reheat*, allowing ongoing control of the mechanical configuration by the system to adjust the amount of reheat to meet a set leaving air temperature.

THE REHEAT GOAL

In evaluating these systems, it is important to have a goal in mind. A simple goal that can be set for reheat is to match neutral conditions (e.g., 75°F & 50% RH). Desert Aire *Technical Bulletin 14* explains the benefit of matching those conditions.

As will be seen, the real challenge for pretreatment lies in hitting the neutral air sensible temperature target. Moisture removal methods that employ fixed reheat can adequately control humidity, but pay a price in excess energy usage due to limited temperature control. Methods that employ variable reheat are better able to both remove moisture and mimic neutral air temperatures, although some methods are more successful than others. The narrower the range of temperature conditions (around the neutral point) faced by the air handler, the less the amount of heating or cooling required.

Taking into consideration the temperature control capabilities, variable reheat leads to more advanced goals. The section entitled “Advantages of Variable Reheat” found later in this brochure, provides a brief explanation of these ideas.

MOISTURE REMOVAL WITH FIXED REHEAT

1. Heat Pipes

Heat Pipes are a passive method of obtaining reheat. In its simplest form, a heat pipe is a metal tube sealed at both ends, evacuated, charged with a refrigerant, and stood on end. The liquid refrigerant at the bottom end readily turns to gas when

that end of the pipe is warmed, and floats to the top end of the pipe. If that end is in a cooler environment the gas condenses, releasing heat. The liquid then flows back to the bottom where the cycle begins again. The net result is heat transfer from bottom to top, without a compressor. Capillary action is sometimes used to help move the liquid, allowing for greater flexibility in configuration.

For pretreatment of 100% outdoor air using an air conditioning unit, a more complicated set of heat pipes is used. (See Figure 2.) The bottoms of the pipes take the form of a bank of coils installed upstream of the evaporator. The tops of the heat pipes comprise another bank of coils downstream of the evaporator. Tops and bottoms are connected by tubes, one set allowing gas to make its way from bottom to top, and another allowing liquid to flow from top to bottom.

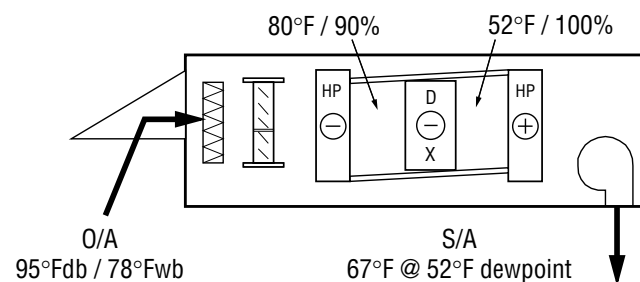

Figure 2) Heat Pipe System Schematic

Outdoor air passes over the upstream set of coils, which is the bottom of the heat pipe. The air is cooled as some of the liquid refrigerant turns to gas and moves through the connecting tubes to the tops of the heat pipes. Meanwhile, the cooled outdoor air proceeds to the air conditioner. Because of the precooling, the air conditioner uses less of its cooling capacity on removing sensible heat and more on removing latent heat. The heat pipes serve to boost the amount of moisture removal done by the air conditioner. Cold air leaving the air conditioner encounters the other bank of coils, the tops of the heat pipes. The gaseous refrigerant releases energy, heating the air, as the refrigerant condenses. The liquid refrigerant then flows through the other tubes back to the bottoms of the heat pipes.

Heat pipe performance depends on the temperature difference between the cooling and the reheat coil banks. As outdoor air temperature decreases, the heat transfer across the heat pipe also is reduced so that eventually little or no reheat is available. Temperatures leaving the air conditioner with heat pipe added may vary significantly as the heat load changes.

2. Air to Air Heat Exchanger

Another form of passive energy transfer when using an air conditioning unit for pretreatment of 100% outside air is the use of an air to air plate heat exchanger. Heat is transferred from outdoor air coming into the air conditioner to the cold air leaving it. Again, the goal is to boost the portion of air conditioning capacity used for removal of latent heat by decreasing the need to remove sensible heat. To a limited extent, the exchanger itself will remove latent heat by condensing moisture on the entering air side.

Outdoor air is introduced into one side of the heat exchanger, and is partially cooled. It then flows over the cold refrigeration coil for moisture removal and additional sensible cooling. The cold, saturated air then passes through the other side of the exchanger for warming before being introduced to the air handler or the space. (See Figure 3.)

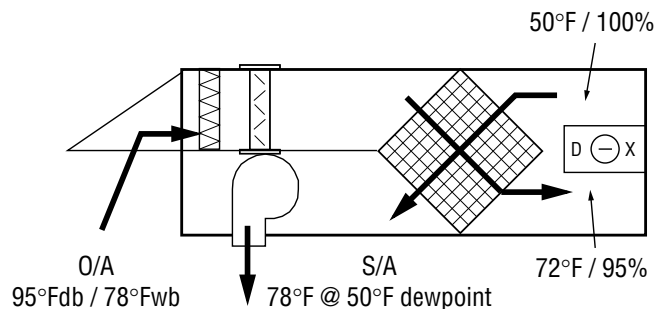

Figure 3) Air to Air Exchanger System Schematic

The efficiency of the heat exchanger is a function of the size and spacing of the aluminum fins and the temperature difference. As with the heat pipe, and for the same reasons, the amount of reheat and therefore the leaving air temperatures can vary significantly.

3. Dehumidifier with Fixed Reheat

In a dehumidifier with fixed reheat, a fixed hot gas reheat coil is installed downstream from the evaporator coil. (See Figure 4.) It accepts a portion of the total heat rejection of the refrigeration circuit, using it in the reheat coil to warm the dehumidified air. The sensible temperature for leaving air can typically be kept in a range of 60°F to 80°F, and this will be true even when the outdoor moist air is cool. The amount of refrigerant going to the reheat coil is set by a fixed or manually controlled valve. Once the valve has been set, leaving air temperatures depend on the entering air temperature and humidity.

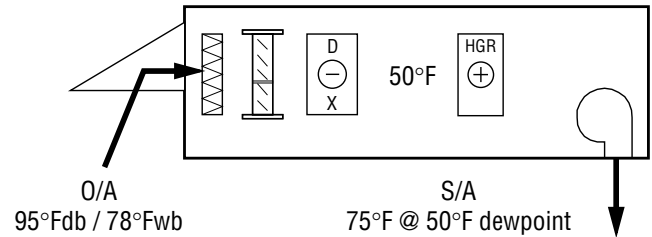

Figure 4) Hot Gas System Schematic

Since only a portion of the total heat to be rejected is used by the reheat coil, an additional condensing element must be added to the system. This element could be an air cooled condenser or a water cooled loop such as a cooling tower.

Control Range for Fixed Reheat

All three forms of moisture removal with fixed reheat generate a similar control range when properly sized. Plotted on a psychrometric chart (shown in Figure 5), this range forms an area bounded by the 55°F dewpoint line at the top, the 43°F dewpoint line at the bottom, the 40% RH line on the right, and the 60% RH line on the left. (The corresponding dry bulb temperature range is from 56°F to 80°F.) Staying within this control range provides low humidity air to the space, eliminating the build-up of mold, mildew, and other humidity-related contaminants.

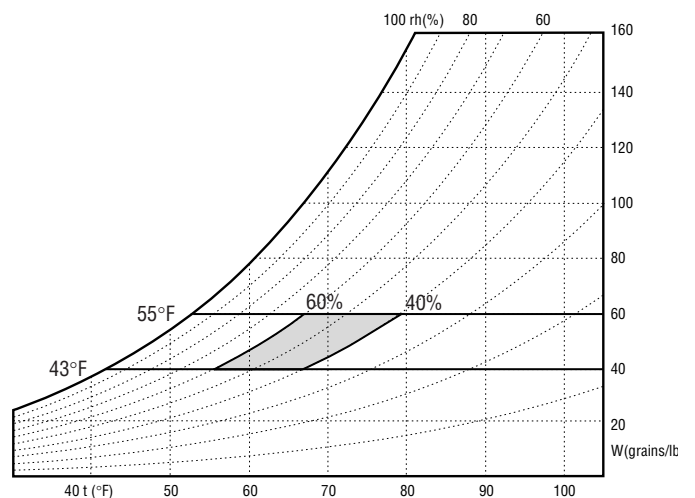

Figure 5) LAT Control Range of Fixed Reheat Systems

The unit's performance will vary based on entering air conditions. At full load design, the supply air will be at the upper right point in the range. At minimum part load prior to turning off the refrigeration system, the supply air will be at the lower left point.

MOISTURE REMOVAL WITH VARIABLE REHEAT

Motivation for Variable Reheat

As noted earlier, a simple goal that may be established for pretreatment systems is to match neutral conditions, most often expressed as 75°F at 50% RH. The peak 60% RH shown in Figure 5 will be acceptable. But the leaving air sensible temperature varies from 56°F to 80°F, undesirable because auxiliary heating or cooling will be required.

To more closely approximate neutral conditions, the moisture removal system must control the amount of reheat so that the discharge temperatures can be set to a specific dry bulb temperature. Since neither heat pipes nor air to air exchangers are readily controllable, variable reheat is implemented in a dehumidifier, using one of three approaches.

1. Dehumidifier with Face and Bypass Damper

The face and bypass damper system (shown in Figure 6) regulates the amount of air that flows over the reheat condenser and so controls how much heat is transferred to the air stream. The remainder of the air needed to keep overall air flow constant bypasses the coil. This system controls the discharge temperature to a specific value by regulating the damper positions with a feedback controller.

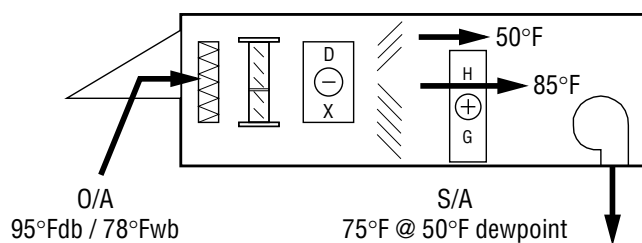

Figure 6) Face & Bypass System Schematic

2. Dehumidifier with Staged or Stepped Reheat

Stepped or staged reheat will use either a series of solenoid valves or an incremental stepped valve to adjust the amount of refrigerant allowed to the reheat condenser. Adjustments are made in specific increments, such as 20% of refrigerant volume flow. These systems provide an intermediate level of control of the reheat condenser. Leaving air temperatures can be held in a narrower range ($\pm 5^\circ\text{F}$) than with a fixed reheat system, but can not be held at a specific level.

3. Dehumidifier with Variable Hot Gas Reheat

A variable hot gas reheat system relies on an infinitely controlled valve to allow specific amounts of hot gas to the reheat condenser. This system very closely matches the leaving air temperature to the user's setpoint. A sensor providing leaving air temperature information to the controller is required. The controller uses proportional/integral control logic to position the hot gas throttling valve. (Desert Aire has a patent pending on this method of hot gas reheat control.)

Control Range for Variable Reheat

Variable reheat, by keeping dehumidifier leaving air temperature close to a specific value, allows the overall system to better control the sensible temperature of leaving air regardless of outdoor conditions. Figure 7 shows a typical control range for variable reheat systems. Note that a staged or stepped hot gas reheat will show greater variability than is depicted in Figure 7, with the width of range dependent on the size of the steps involved. The greatest precision is offered by the variable hot gas reheat, which is able to hold leaving air temperature within one half a degree Fahrenheit over a wide range of conditions.

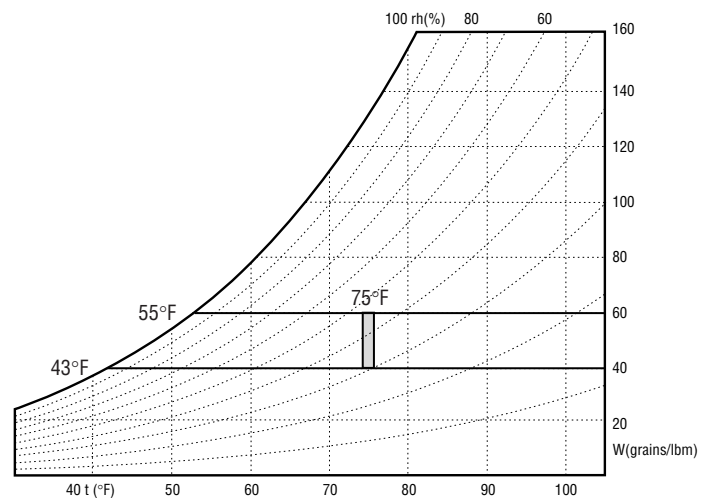

Figure 7) Leaving Air Control Range of Variable Reheat Systems

4. Variable Reheat with Enthalpy Wheel and Auxiliary Heat

The easiest way to explain “variable reheat with enthalpy wheel and auxiliary heat” is to start at the beginning, or the point where outdoor air enters a dehumidifier. The first component that the air encounters is an energy recovery wheel.

Several different types of energy recovery wheels can be incorporated into a ventilation system. We use an enthalpy wheel in our TotalAire dehumidifiers because it specifically transfers both sensible and latent energy between outdoor and exhaust air streams.

The core of an enthalpy wheel can be made from a variety of materials such as paper, metal or plastic, which is coated with a desiccant. This coating enables the wheel to transfer both sensible and latent energy between air streams. (See Figure 8) For a more detailed explanation of the various energy wheels available, please refer to our *Technical Bulletin 19 - Energy Recovery Wheel Technology*.

Combining an enthalpy wheel with a dehumidifier with variable hot gas reheat can provide vast energy savings. The result is a hybrid unit that offers the best of both worlds.

recommends using auxiliary electric or gas heat. By integrating one of these options into the unit, the air temperature can often be completely controlled with a single dehumidifier without the need for an air handler or other additional equipment.

In evaluating this entire system, - variable reheat with an enthalpy wheel and auxiliary heat - an enthalpy wheel is extremely efficient at reducing peak loads in the summer and winter. It can lessen the load placed on the refrigeration system, which in turn greatly saves both energy and money. An enthalpy wheel can even reduce the required dehumidifier capacity size by approximately half. When incorporating a wheel with variable reheat, the unit efficiently maintains a precise preset LAT without placing a heavy burden on the refrigeration system to maintain temperature control.

A DVANTAGES OF VARIABLE REHEAT

The goal of achieving a narrower control range for leaving air temperature is to ensure occupant comfort as defined by ASHRAE 55-1985, and to do so with low installed cost and minimum energy consumption.

Fixed reheat, with its broader range of leaving air temperatures, leaves the designer in a difficult situation. Additional air conditioning capacity will be needed when outdoor air is warm and moist. Auxiliary heating will have to be done when outdoor air is cool and moist. The results are increased installed cost and excessive energy usage.

Variable reheat, with a narrower range of leaving air temperature, allows the designer to proceed with more flexibility and certainty. The dehumidifier can be asked to target certain leaving air temperatures, depending on conditions. At times, the dehumidifier alone can cool or heat sufficiently so that no cooling or heating by the air handler is required. At other times, the dehumidifier can supplement the cooling or heating of the air handler. Additional air conditioning capacity is avoided, and energy usage is minimized. The more precise the variable reheat, the greater the energy savings.

Auxiliary Heating Requirements

To get an idea of the additional energy consumed due to using fixed reheat versus variable reheat, consider an example. Table 1 shows the amount of energy, in the form of auxiliary heating, that is required when leaving air temperature drops below a prescribed 75°F room temperature for a 2000 CFM outdoor air dehumidification system. Also shown is the size (in kW) of auxiliary electric heater that would be needed to raise the leaving air temperature to the desired 75°F neutral condition.

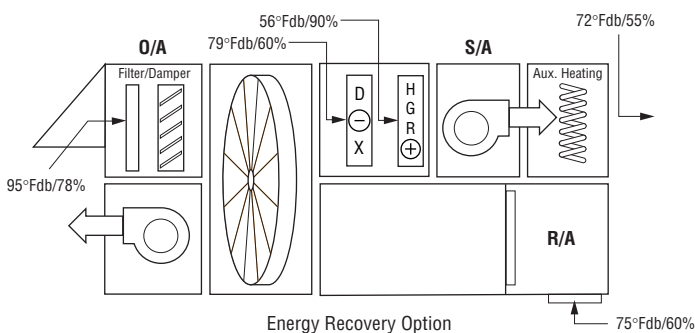

Figure 8) TotalAire Dehumidifier With Energy Recovery and Options

The enthalpy wheel provides first stage cooling or heating. For instance, in the summer the wheel removes moisture from incoming air and pre-cools it to lighten the load on the evaporator coil. Likewise, in colder temperatures (winter application) the wheel will inject moisture into supply air and pre-warm it to reduce the load on the reheat coil. In both the summer and winter modes, the wheel saves energy.

The second option that provides exceptional energy savings is the precise control of leaving air temperature (LAT). As previously mentioned, Desert Aire is able to offer this capability using our patented proportional plus integral plus control logic. Essentially, this technology adjusts the hot gas reheat condenser valve to maintain a LAT that matches the preset temperature predetermined by the user.

Although an enthalpy wheel with precise LAT control is extremely efficient at providing exact air temperatures while simultaneously conserving energy, there are situations when additional heating is needed. In these instances, Desert Aire

Dehumidifier LAT	Extra Heat MBH	Electric Heat kW
75	0	0
70	11	3.2
65	22	6.3
60	33	9.6

Table 1) Amount of Auxiliary Heating to Maintain 75°F LAT at 2,000 CFM

How much extra heating would be necessary over the course of a year? This question is difficult to answer, but a bin method can be used to estimate total heat usage. Since the dehumidifiers are selected based on maximum ambient design conditions, it is easy to conclude that the leaving air temperatures of fixed reheat systems will be below the design “neutral” condition more than 95% of the time. During this period, some additional heat would be required. Consistently, calculations show that systems using fixed reheat will cost significantly more to operate than systems using variable reheat.

As a quick comparison of overall operating characteristics for all of the fixed and variable reheat pretreatment methods discussed, please refer to Table 2. It summarizes the operating characteristics of various 2000 CFM pretreatment units that are designed to treat 95 dry bulb/78 wet bulb air to a design dewpoint of 50-55°F. The key point of comparison is the “Part

Type of Pretreatment Used	Compressor Size (HP)	Blower Size (HP)	Full Load (kW)	Part Load (kW)
Dehum w/Fixed Hot Gas Reheat*	15	2	18.3	18 to 28
Dehum w/Staged Hot Gas Reheat*	15	2	18.3	18 to 24
Dehum w/Variable HotGas Reheat*	15	2	18.3	18.3
AC w/Heat Pipe (3 row evap.)	15	2	18.3	18 to 28
AC w/Plate Heat Exchanger	10	3	14.0	14 to 24
Dehumidifier w/Variable HGR and Enthalpy Wheel	7.5	3	10.7	10.7

*Uses 8 row evaporator coils

Table 2) Compressor and blower size required for various pretreatment unit types, and heating capacity required to maintain leaving air at neutral conditions.

Load” column, which shows the ability of variable hot gas reheat to minimize the need for heating the air leaving the pretreatment unit.

INTERNAL SENSIBLE COOLING

Fixed and variable reheat should also be compared with respect to cooling needs. Since a dehumidifier cools air as it removes moisture, when it’s running it can provide first stage cooling.

For most climates, there will be long time periods when moisture removal is required but the internal sensible cooling load is significantly lower than the design conditions used to size the air conditioning. The dehumidifier with variable reheat can be set up to discharge cool air into the space when the room is occupied, often meeting the internal sensible cooling load without energizing the main air conditioning system. Using this technique, the overall HVAC system can achieve significant operational savings, and often a smaller capacity air conditioning system can be installed.

CONCLUSION

Moisture must be a key concern of the design engineer when implementing ASHRAE 62 ventilation requirements. Pretreatment of outdoor air for moisture removal can provide a cost-effective way to prevent moisture from creating indoor air quality problems.

When pretreatment is used, various approaches for energy recovery are available when recovery from exhaust air is not a possibility. Heat pipes, air-to-air heat exchangers, and some dehumidifiers recover energy via *fixed* reheat. While these methods can provide sufficient moisture removal capacity and do recover at least some energy, the level of temperature control is rather limited. The air handler must usually heat or cool to adjust the temperature.

Dehumidifiers with variable reheat both remove moisture and regulate the amount of hot gas reheat to control leaving air temperature. The annual energy savings over fixed reheat are significant, because the need for further heating and cooling is much decreased. The most precise control, and therefore the greatest energy savings, is provided by a dehumidifier with variable hot gas reheat.

OPTIMIZING SOLUTIONS THROUGH SUPERIOR DEHUMIDIFICATION TECHNOLOGY

N120 W18485 Friestadt Road, Germantown, WI 53022 sales@desert-aire.com

Ph: (262) 946-7400 - www.desert-aire.com

